

EN

**HONDA**

# Owner's Manual

## Original Instructions



# Honda

## Robotic Lawnmower

### HRM310/520



***Mimo***



Congratulations on your selection of a Honda Robotic Lawnmower. We are confident that you will enjoy the benefit of your Honda Robotic Lawnmower as we take great pride in creating the finest quality lawn care products.

We want to help you get the best results from your new robotic lawnmower and to operate it safely. This manual contains all the information on how to do that; please read it carefully.

Your Honda servicing dealer is dedicated to your satisfaction and will be pleased to answer your questions and concerns.

Honda Motor Co., Ltd. reserves the right to make changes at anytime without notice and without incurring any obligation.

No part of this publication may be reproduced without written permission.

This manual should be considered a permanent part of the robotic lawnmower and should remain with it if it is resold.

Pay special attention to statements preceded by the following words;

**▲ WARNING**

**Indicates a strong possibility of severe personal injury or death if instructions are not followed.**

**CAUTION:**

**Indicates a possibility of personal injury or equipment damage if instructions are not followed.**

**NOTE:**

Gives helpful information.

If a problem should arise, or if you have any questions about the robotic lawnmower, consult an authorised Honda dealer.

Honda robotic lawnmowers are designed to give safe and dependable service if operated according to instructions.

**▲ WARNING**

**- Operating a robotic lawnmower requires special attention to ensure the safety of the operator and the safety of others. Read and understand this Owner's Manual before operating the robotic lawnmower; failure to do so could result in personal injury or equipment damage.**

\* The illustrations may vary according to the type

Make sure to have your dealer fill in "LAWN DIAGRAM" (☞ page 79) and "DEALER CHECKSHEET" (☞ page 80) with details on the installation it has performed and the settings it has configured.

# CONTENTS

## Setting

### Safety Instructions

#### Preparation

- Component identification (☞ page 10)
- Installation (☞ page 12)
- Setting up the lawnmower (☞ page 15)



#### Menu Settings

- Setting the work timer (☞ page 27)
- Setting the lawnmower operation (☞ page 31)
- Checking the system (☞ page 43)
- Viewing history (☞ page 46)
- Setting the system (☞ page 49)



## Operation

### Usage

- Checking the mowing area (☞ page 53)
- Checking the lawnmower (☞ page 54)
- Turning on / off the power (☞ page 54)
- Operating the lawnmower with the Auto mode (☞ page 55)
- Adjusting the height of the blades (☞ page 57)

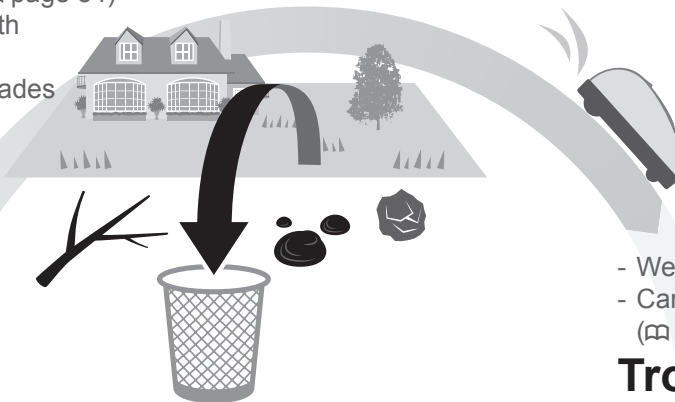

### Work (Auto)

According to settings, the lawnmower works automatically.

- Weekly checks (☞ page 58)
- Carrying the lawnmower (☞ page 59)

### Troubleshooting

(☞ page 60)

## Periodical Usage

### Maintenance

- Periodic inspection and maintenance (☞ page 63)
- Maintenance procedures (☞ page 63)

### Storage

(☞ page 70)





|  |           |
|--|-----------|
| <b>1 OVERVIEW</b> .....                              | <b>4</b>  |
| How the Honda Robotic Lawnmower works.....           | 4         |
| Features.....  | 4         |
| <b>2 SAFETY INSTRUCTIONS</b> .....                   | <b>6</b>  |
| Precautions.....                                     | 6         |
| Label locations.....                                 | 9         |
| Observe the following points for your safety.....    | 7         |
| <b>3 PREPARATION</b> .....                           | <b>10</b> |
| Component identification.....                        | 10        |
| Setting up the lawnmower.....                        | 15        |
| Installation.....                                    | 12        |
| <b>4 MENU SETTINGS</b> .....                         | <b>25</b> |
| Menu overview.....                                   | 25        |
| Setting the work timer.....                          | 27        |
| • Work timer.....                                    | 27        |
| • Seasonal timer.....                                | 29        |
| Setting the lawnmower operation.....                 | 31        |
| • Auto mode.....                                     | 31        |
| • Garden layout.....                                 | 40        |
| Checking the system.....                             | 43        |
| • Check signal.....                                  | 43        |
| Viewing history.....                                 | 46        |
| • Operation history.....                             | 46        |
| • Fault history.....                                 | 48        |
| Setting the system.....                              | 49        |
| • Language.....                                      | 49        |
| • Date and Time.....                                 | 50        |
| • Factory reset.....                                 | 52        |
| • Mowing start points.....                           | 28        |
| • Quiet timer.....                                   | 30        |
| • Manual mode.....                                   | 38        |
| • Homing setup.....                                  | 41        |
| • Test start points.....                             | 44        |
| • Work history.....                                  | 47        |
| • Display/Sound.....                                 | 49        |
| • Security.....                                      | 51        |
| • Help.....  | 52        |
| <b>5 USAGE</b> .....                                 | <b>53</b> |
| Checking the mowing area.....                        | 53        |
| Checking the lawnmower.....                          | 54        |
| Operating the lawnmower in the Auto mode.....        | 55        |
| Weekly checks.....                                   | 58        |
| Connecting to a power source.....                    | 53        |
| Turning on / off the power.....                      | 54        |
| Adjusting the height of the blades.....              | 57        |
| Carrying the lawnmower.....                          | 59        |
| <b>6 TROUBLESHOOTING</b> .....                       | <b>60</b> |
| Before contacting your dealer.....                   | 60        |
| Resolving problems.....                              | 62        |
| Messages.....  | 60        |
| <b>7 MAINTENANCE</b> .....                           | <b>63</b> |
| Periodic inspection and maintenance.....             | 63        |
| Maintenance procedures.....                          | 63        |
| <b>8 STORAGE</b> .....                               | <b>70</b> |
| Winter Storage.....                                  | 70        |
| Getting your lawnmower ready for the new season..... | 70        |
| <b>9 TECHNICAL INFORMATION</b> .....                 | <b>71</b> |
| Specifications.....                                  | 71        |
| <b>10 APPENDIX</b> .....                             | <b>72</b> |
| Manual mode operation.....                           | 72        |
| “EC Declaration of Conformity”                       |           |
| CONTENT OUTLINE.....                                 | 76        |
| Major Honda Distributor Addresses.....               | 75        |
| <b>LCD MENU INDEX</b> .....                          | <b>78</b> |
| <b>LAWN DIAGRAM</b> .....                            | <b>79</b> |
| <b>DEALER CHECKSHEET</b> .....                       | <b>80</b> |
| <b>QUICK GUIDE</b> .....                             | <b>82</b> |

# 1 OVERVIEW

## How the Honda Robotic Lawnmower works

### Configuring the system

The mowing area is determined by the boundary wire that emits a signal; when the lawnmower detects the boundary it turns and it cuts the grass randomly. When battery starts running out, it goes back to the docking station.

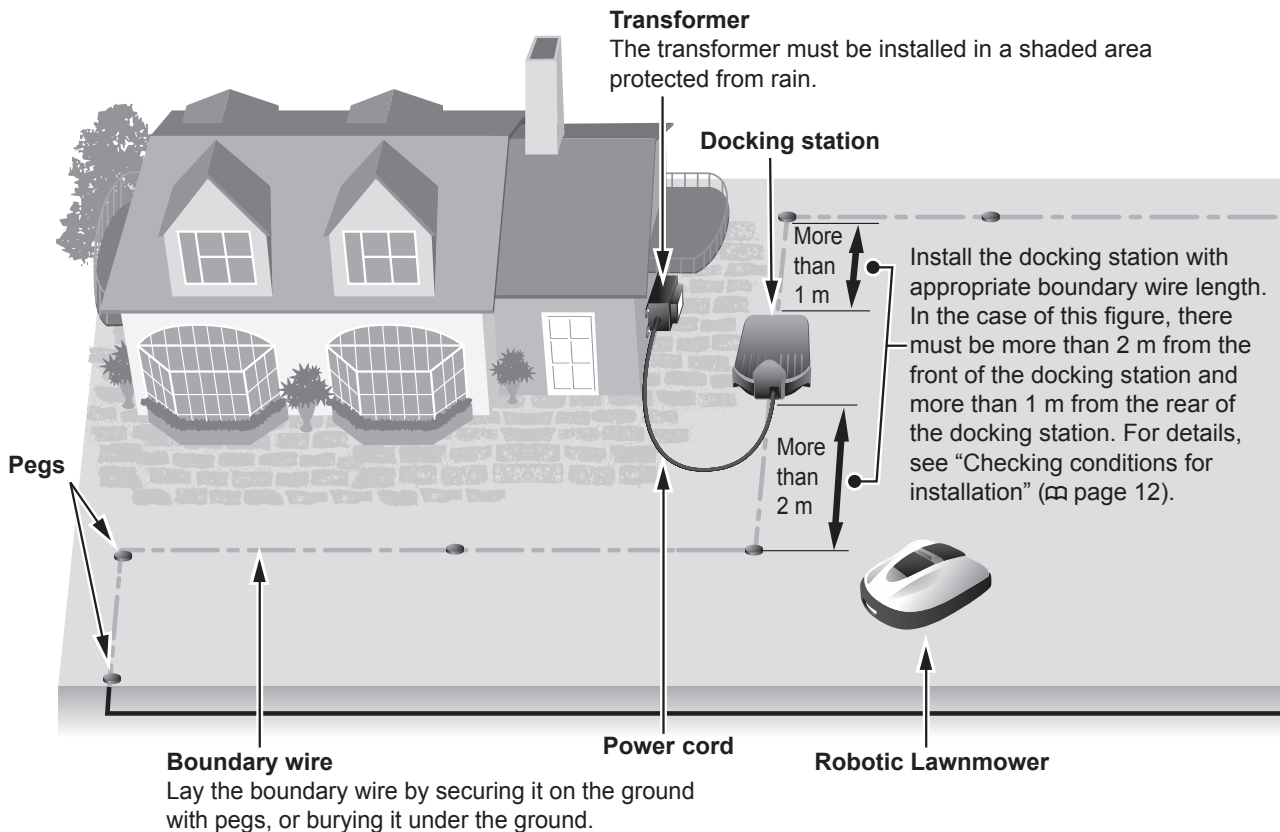

## Features

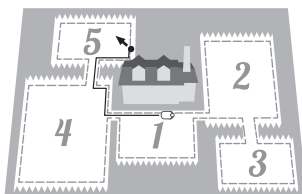

### Mowing start points

You can designate the start points from which the Honda Robotic Lawnmower will start mowing. Mowing start points allow your lawnmower to reach other areas which are difficult to access. Some mowing start points can be set by laying a boundary wire, increasing efficiency.

**NOTE:**

- You can configure the following start points for each model:  
HRM310: 3 start points  
HRM520: 5 start points



### Operation timer

The Honda Robotic Lawnmower has multiple settings for designating the day and time the lawnmower operates. You can configure the lawnmower to run on your days off, or during certain times that are convenient for you.

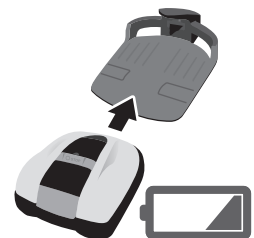

### Convenience

After configuring the Honda Robotic Lawnmower, it starts and stops mowing without any prompting. When the timed programme is complete or the battery's charge becomes low, the lawnmower automatically returns to its docking station and recharges its internal battery.

## ● Laying boundary wire

The boundary wire location determines the parameters of the mowing area, this area may consist of multiple sections in which the lawnmower can operate. For mowing start point setup and detailed information please see “4 MENU SETTINGS” (☞ page 25).

The work area must conform to the following conditions if it includes sloping areas.

- The lawnmower can operate on slopes of 24° (45%). Do not include slopes in the work area that are more than 24° (45%).
  - Lay the boundary wire in locations that have a slope of less than 10° (17%).
  - If the location in which you are laying the boundary wire has a slope that is steeper than 10° (17%), do the following.
    - Do not lay the boundary wire laterally across a slope that is steeper than 10°.
    - Lay the boundary wire laterally across a relatively flat space, with a slope of less than 10°, that comes after the location where the slope is more than 10° (17%). (Refer to the diagram below.)
- \* Laying the boundary wire where the slope is too steep has a bad effect on the lawnmower. This is because the lawnmower follows along where the boundary wire has been laid.

Leave 5 mm of space or less between parts of the boundary wire.  
Make sure that parts of the boundary wire do not overlap or cross.

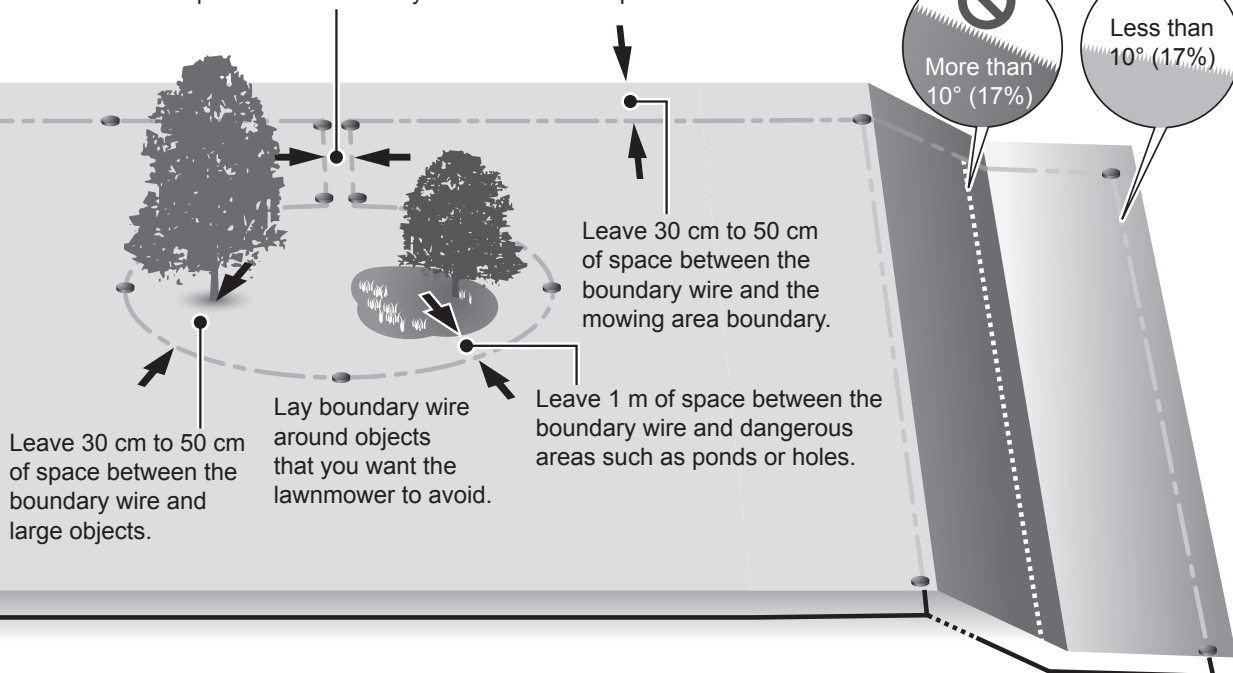

### NOTE:

- Make sure to fill in “LAWN DIAGRAM” referring to the layout of boundary wire (☞ page 79).



### Safety

Blades on the lawnmower automatically stop when:

- You lift the lawnmower.
- The lawnmower is on a surface with a slope that is too steep.
- The lawnmower becomes overturned.



### Quiet operation

The motor and rotating blades of the Honda Robotic Lawnmower operate much quieter than traditional engine lawnmowers.

## ● Useful features

### Seasonal timer (☞ page 29)

The growth speed of lawn depends on the season. With this function, you can configure the ratio of the mowing time for each season.

### Quiet timer (☞ page 30)

You can set the blade speed, wheel speed and timer for operating the lawnmower quietly.

### Spiral cutting (☞ page 36, 38)

With this function, the lawnmower can be focused on mowing the area where the lawn is not completely mown, or the growth speed of the lawn is fast.

### Edge cutting (☞ page 35, 38)

With this function, you can mow the unmown area along the boundary wire.

## 2 SAFETY INSTRUCTIONS

### Precautions

Carefully observe the following precautions.

- Make sure to keep your hands, feet and any other body parts away from the rotating blades.
- Do not touch sharp components such as the blades or blade disc other than when performing maintenance. If you do, you may be injured.



- Always press the manual STOP button first before you physically interact with the lawnmower such as lifting, turning sideways or upside down. If you do not, you may come in contact with the blades and become injured.
- Never allow children, persons with reduced physical, sensory or mental capabilities or lack of experience and knowledge or people unfamiliar with this owner's manual to use the lawnmower. Local regulations may restrict the age of the operator.
- Keep in mind that the operator or user is responsible for accidents or hazards occurring to other people or their property.
- Observe the following precautions when operating the lawnmower or peripheral devices.
  - Stand comfortably so you do not lose your balance.
  - Watch your step on uneven ground.
  - Walk, do not run.
- Wear long pants and sturdy shoes when nearby or inside the work area while the lawnmower is operating.
- Before using the robotic lawnmower or entering the work area, persons using a pacemaker or other medical device should consult a doctor.
- Do not ride on the lawnmower, push the lawnmower, or use it for anything other than its intended purpose. An accident may occur or the lawnmower may be damaged.



- Never use the lawnmower in the immediate vicinity of people, especially children or pets.
- Carry out your mowing operation only within the boundary wire area.

- Do not use automatic lawn watering systems while the lawnmower is operating, because the watering equipment may become damaged and the likelihood of water penetrating into the lawnmower is greatly increased. Adjust the work timer of the lawnmower so the watering systems and the lawnmower do not operate at the same time.



- If there is a risk of adverse weather such as lightning or a storm, stop operation and disconnect the power cord.
- Parts of this product may become warm in direct sunlight. Make sure you do not touch these parts if they become extremely hot or you may burn yourself.
- Do not charge the lawnmower with anything other than the docking station. An accident may occur or the lawnmower may be damaged.
- If the power supply cord is damaged, immediately unplug it from the outlet and contact your dealer. Also, do not touch the damaged part of the power supply cord.
- If there are any holes (such as rabbit holes, etc.) in the work area, fill them in so that the work area is level. Periodically check the work area for holes.

## Observe the following points for your safety

- When carrying the lawnmower, turn it off and carry it as explained in this manual (see page 59) with the blades facing away from you.
- When carrying the lawnmower, make sure to carry it by the designated areas (see page 59). If you carry the lawnmower in any other way, you risk injury from the blades or charging socket of the lawnmower. You may also drop and damage the lawnmower.



- Always use thick work gloves when performing maintenance. If you do not, you may be injured by the blades.



- Before operation, always check the work area and remove any branches, rocks, and other objects that can damage the blades and cause the lawnmower to stop. If you do not, you may be injured from objects that are ejected from the bottom of the lawnmower, or the lawnmower may become damaged.



- Always press the manual STOP button first before you physically interact with the lawnmower. If you do not, you may become injured, prevent the lawnmower from connecting to the docking station, or stop the lawnmower's operation.
- When performing maintenance on the lawnmower, make sure to press the manual STOP button and stop the lawnmower from moving. If the lawnmower is moving, an accident may occur.

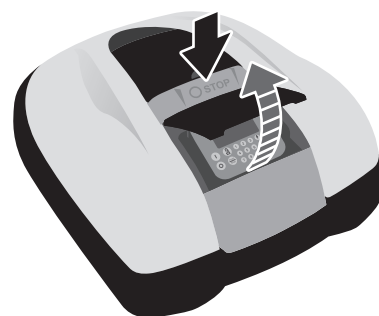

- Lay the boundary wire so that it is held firmly in place, and perform periodic checks after laying it to ensure that it has not slackened. If the boundary wire protrudes from the ground, you or someone else may trip on it and fall.
- Do not touch the exposed tip of a boundary wire that has been cut or damaged. You may be injured or electrocute yourself.
- If you find that the boundary wire has been cut, turn off the lawnmower, unplug the transformer's plug from the power outlet (House), and contact your dealer.
- Do not touch the charging socket. If you touch it, you may become injured.
- Observe the following points when touching the power outlet (House), power cord, and transformer. If you do not, you may be electrocuted.
  - Do not touch the power outlet (House), cord, and transformer with wet hands.
  - Do not touch the power outlet (House), cord, and transformer if the power outlet (House), power cord, or transformer is wet.
- Perform periodic checks to confirm that no dust, dirt, or other things have gathered in or on the power outlet (House), power cord, or transformer. If such things are present, remove them or they may cause a fire.
- Make sure that the contents of "SAFETY INSTRUCTIONS" are absolutely clear to persons who may come in contact with the robotic lawnmower. If you do not, an accident may occur.
- When connecting the plug, hold the plug by its designated grip area. Failure to hold the plug correctly may result in electrocution if you touch the connector area.
- People who are not thoroughly familiar with this Owner's Manual should not come into contact with the lawnmower other than to stop it.
- When approaching the operating lawnmower, pay attention to materials that may be scattered by the blades.
- Do not use the lawnmower if the outer casing is damaged.  
The blade may accidentally cut you or you may be injured by debris thrown off by the blade.
- Never attempt to tamper with the lawnmower. It can cause an accident as well as damage to the lawnmower.

### **Disposal**

To protect the environment, do not dispose of this product, battery, etc. carelessly by leaving them in the waste.

Observe the local laws and regulations or consult your authorised Honda dealer for disposal.





# Label locations

## ● POSITIONING OF SAFETY LABELS

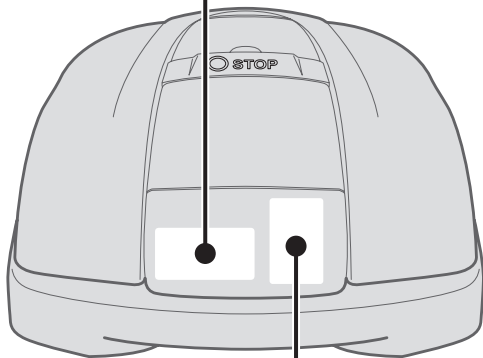
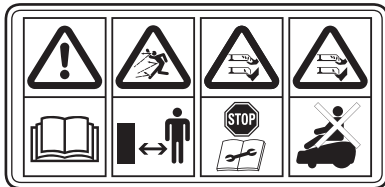
Your lawnmower should be used with due care and attention. Therefore, figured labels have been placed on various parts of the machine to remind you of the main precautions to be taken. Their full meaning is explained later on. These labels are an integral part of the lawnmower and so, if any of them should become detached or illegible, contact your servicing dealer for their replacement. You are also asked to carefully read the safety regulations in the applicable chapter of this handbook.





  
**The Honda Robotic Lawnmower is designed to give safe and dependable service if operated according to instructions.**  
**Read and understand the Owner's Manual before operating the Honda Robotic Lawnmower. Failure to do so could result in personal injury or equipment damage.**





  
**Keep all persons and pets away from the Honda Robotic Lawnmower area.**



  
**Do not touch the rotating blade.**  
**Beware of sharp blades : blade in movement.**  
**Operate the disabling device before working on or lifting the machine.**



  
**Do not ride on the machine. This machine is not a toy, keep children away from the machine.**





## ● POSITIONING OF CE MARK, SERIAL NUMBER, AND OTHER INFORMATION

The manufacturer's name and address, CE mark, serial number, and other information are in the following locations indicated in the illustration.

Manufacturer name and address — **Honda France Manufacturing S.A.S.  
Rue des Châtaigniers  
Pôle 45 - 45140 Ormes  
France**

Model type — 

Serial No. — 

Year of manufacturing — 

Cutting width —  cm

Rated voltage —  V

Rated power —  W

Mass (Weight) —  kg

CE mark — 



 Do not dispose of electric equipment together with household waste material. If electrical appliances are disposed of in landfills or dumps, substances can leak and react and enter into the foodchain, damaging your health and well-being. For further information on the disposal of this product, please contact your dealer or your nearest domestic waste collection service.

# 3 PREPARATION

## Component identification

### ● Body

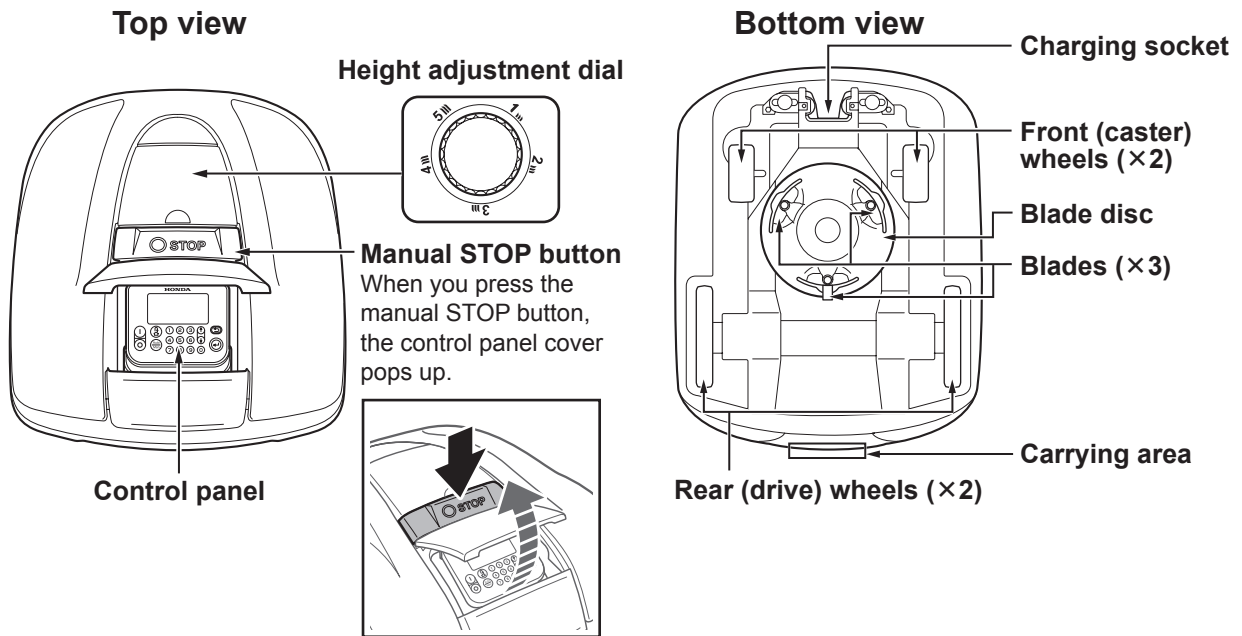

### ● Docking station

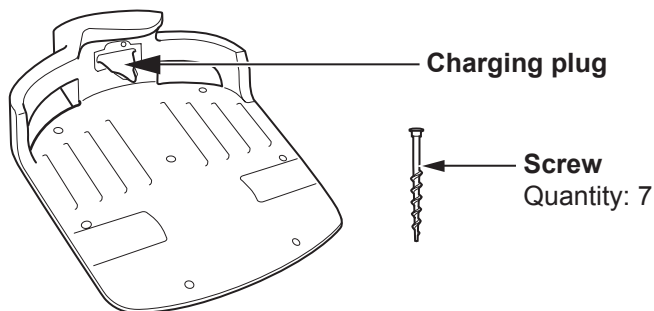

The lawnmower recharges at the docking station, and returns to the docking station when mowing is finished or the battery's charge becomes low. (You can configure the battery level for returning to the docking station from 10% to 50%.)

### ● Supplied items

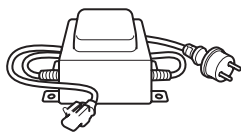

#### Transformer

Install the transformer off the ground. After making all other connections, connect the transformer to the power outlet (House).



#### Power cord

Connect the power cord to the transformer and docking station.

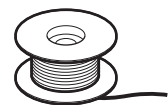

#### Boundary wire

Lay boundary wire around the area in which you want the lawnmower to operate.  
Length for HRM310: 200 m  
Length for HRM520: 300 m



## ● Control panel

### Display

The home screen and menus can be seen here while the lawnmower is turned on.

### On button

Press to turn on the power.

### Off button

Press to turn off the power.

### NOTE:

- The timer does not function if you turn off the power.

### Home button

Press to automatically return the lawnmower to the docking station after you close the control panel cover.

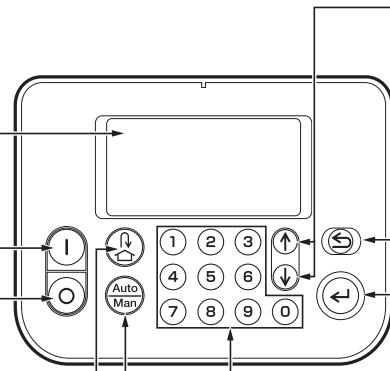

### Up/down arrow buttons

Press to navigate to the previous/next item in the display.

### Back button

Press to return to the previous menu in the display. (The back button cannot be used in some cases.)

### Enter button

Press to enter your selection in the display.

### Number buttons

Press to enter numbers in the display menus. When there is a number to the left of a display menu item, you can press the corresponding number button to highlight that item.

### Auto/Manual selection button

Press from the home screen to switch between operation modes. You can choose from Auto or Manual modes. For details, see "4 MENU SETTINGS" (☞ page 25).

## ● Home screen

Mode selection button on which Lawnmower setting status is displayed as below:

| Icons | Description                                       |
|-------|---|
|       | Auto mode is set.                                 |
|       | Manual mode is active and no timer is set.        |
|       | The lawnmower will return to the docking station. |

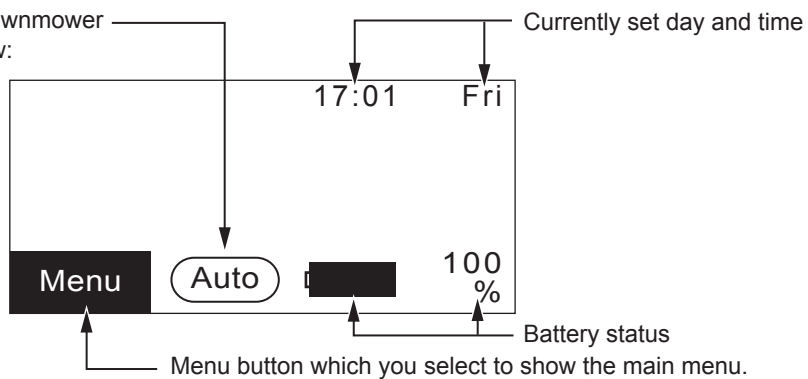

## ● Item selection screen

Name of the first level menu

Selectable menu items and current setting status.

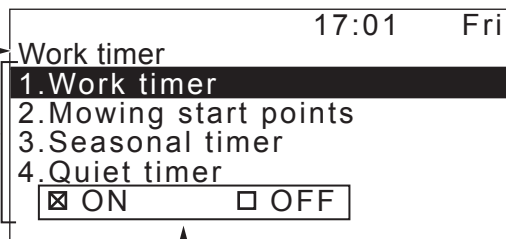

You can display the previous screen by pressing the ⏪ button.

Selectable boxes to which you add a check by pressing the ☑ button.



### Pegs

Use pegs to hold the boundary wire in place when laying it.  
Quantity for HRM310: 200  
Quantity for HRM520: 300

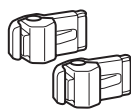

### Connectors for the boundary wire

Use connectors to bind the boundary wire and connect it to the docking station.  
Quantity: 2

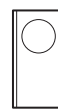

### Ruler

Part of the packaging of this product is a ruler. This ruler is used to check the position of the boundary wire installation.

### Spare Blades

Use spare blades to replace the worn ones.  
Quantity: 9

# Installation

We strongly recommend that an authorised Honda dealer performs the installation of your Robotic Lawnmower. Installation by an authorised Honda dealer will ensure that your system is working correctly.

## Checking conditions for installation

Check with the dealer that performed the installation if the docking station and boundary wire are installed according to the conditions below. Also periodically confirm that these conditions are still met.

If any of these conditions are not met, consult your dealer.

It is recommended that the mains power supply is professionally installed in line with local laws and regulations.

### Conditions for installing the docking station

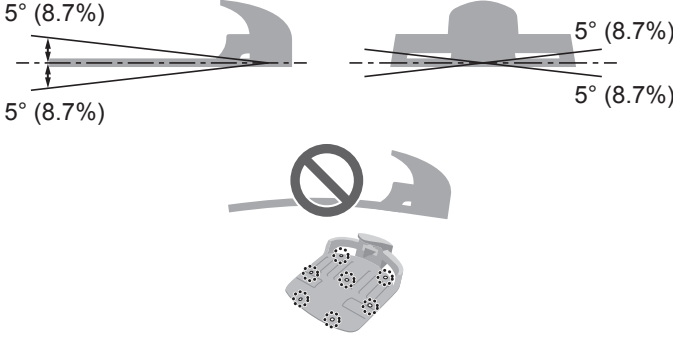
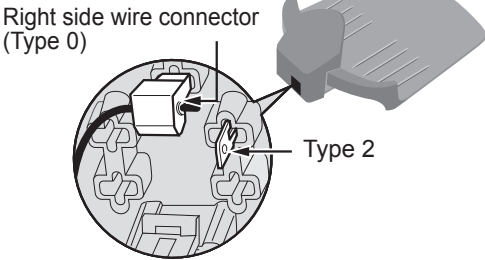
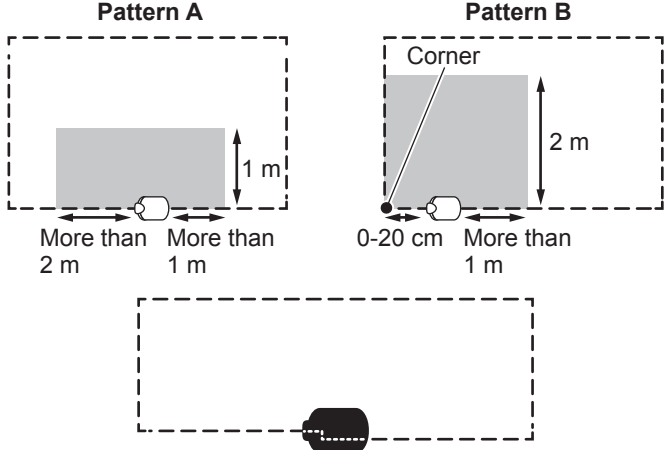
| Image  | Condition  |                           |                          |                           |  |                |  |                      |  |         |                          |                           |                          |                           |        |        |        |        |   |
|--|--|---------------------------|--------------------------|---------------------------|--|----------------|--|----------------------|--|---------|--------------------------|---------------------------|--------------------------|---------------------------|--------|--------|--------|--------|---|
|   | <ul style="list-style-type: none"> <li>The docking station must be installed on a flat surface with an inclination of no more than 5° (8.7%).</li> <li>The docking station must not be curved.</li> <li>The screws must be firmly tightened.</li> <li>Before installing the docking station, check the ground condition which may vary seasonally. It may be necessary to maintain the ground with the season.</li> <li>If installing the docking station directly on the lawn, cut the grass on which the docking station will be located as short as possible.</li> <li>Because of a wrong installation of the docking station, the lawnmower may not be charged.</li> </ul> |                           |                          |                           |  |                |  |                      |  |         |                          |                           |                          |                           |        |        |        |        |   |
| <br><table border="1" data-bbox="236 1317 908 1608"> <thead> <tr> <th rowspan="2">Boundary wire length</th> <th colspan="4">Docking direction</th> </tr> <tr> <th colspan="2">CW (Clockwise)</th> <th colspan="2">ACW (Anti-clockwise)</th> </tr> </thead> <tbody> <tr> <td rowspan="2">0-800 m</td> <td>Left side wire connector</td> <td>Right side wire connector</td> <td>Left side wire connector</td> <td>Right side wire connector</td> </tr> <tr> <td>Type 2</td> <td>Type 0</td> <td>Type 2</td> <td>Type 0</td> </tr> </tbody> </table> | Boundary wire length   | Docking direction         |                          |                           |  | CW (Clockwise) |  | ACW (Anti-clockwise) |  | 0-800 m | Left side wire connector | Right side wire connector | Left side wire connector | Right side wire connector | Type 2 | Type 0 | Type 2 | Type 0 | <p>You need to set the loop direction CW (Clockwise) or ACW (Anti-clockwise) when the lawnmower returns to the docking station. You also need to connect the connectors of the boundary wire with the terminals of the docking station with reference to the left table.</p> <p><b>NOTE:</b></p> <ul style="list-style-type: none"> <li>If your lawnmower is HRM310, the max length of the boundary wire is 400 m.</li> </ul> |
| Boundary wire length   |  | Docking direction         |                          |                           |  |                |  |                      |  |         |                          |                           |                          |                           |        |        |        |        |   |
|  | CW (Clockwise)   |                           | ACW (Anti-clockwise)     |                           |  |                |  |                      |  |         |                          |                           |                          |                           |        |        |        |        |   |
| 0-800 m  | Left side wire connector   | Right side wire connector | Left side wire connector | Right side wire connector |  |                |  |                      |  |         |                          |                           |                          |                           |        |        |        |        |   |
|  | Type 2   | Type 0                    | Type 2                   | Type 0                    |  |                |  |                      |  |         |                          |                           |                          |                           |        |        |        |        |   |
|   | <ul style="list-style-type: none"> <li>The boundary wire must be laid according to the figure on the left (Pattern A or Pattern B).</li> <li>There must be no obstacles as follows:<br/>Pattern A: within 1 m from the station<br/>Pattern B: within 2 m from the station</li> <li>There must not be foreign objects within the work area near the docking station (in the shaded area indicated in the image).</li> <li>The boundary wire under the docking station must be laid toward the outside of the work area.</li> </ul>  |                           |                          |                           |  |                |  |                      |  |         |                          |                           |                          |                           |        |        |        |        |   |

● Conditions for laying the boundary wire

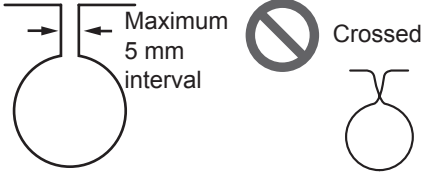
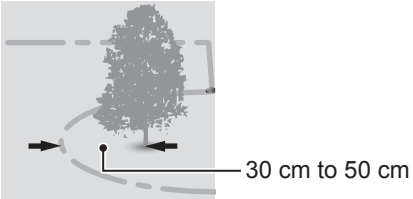
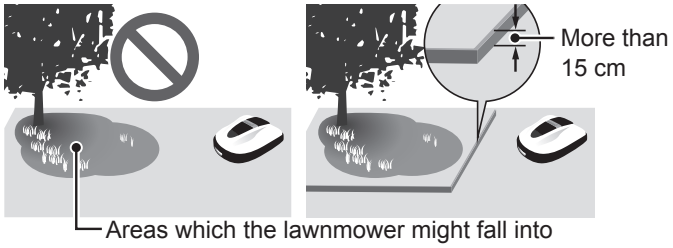
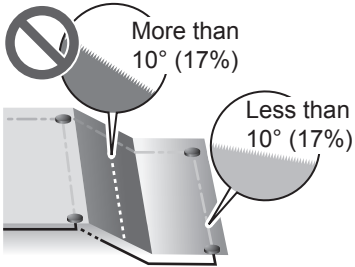
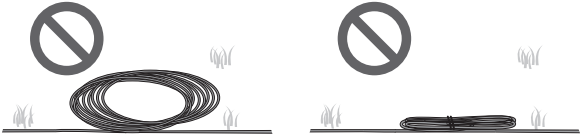
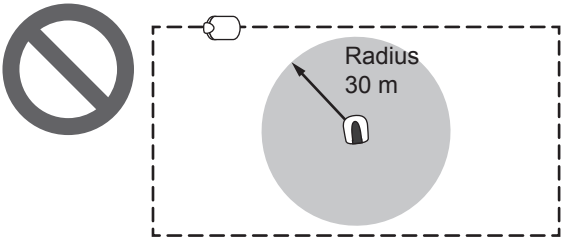
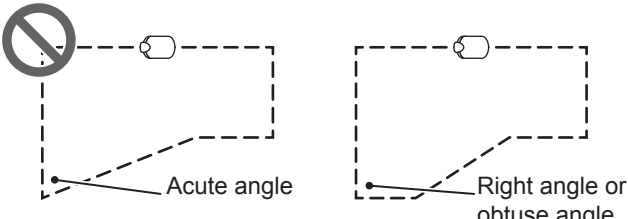
| Image  | Condition   |
|--|---|
| <p>Height of objects which the lawnmower might run on top of</p>  | <p>Lay boundary wire around objects which the lawnmower might run on top of (e.g. rocks, tree roots, etc.); these objects must be removed from the work area.</p>   |
|   | <p>The boundary wire entry and exit points for a round area should be separated by less than 5 mm. (However, the boundary wire should not cross itself.)</p>  |
|   | <p>There must be 30 cm to 50 cm of space between the boundary wire and large objects. (This space can be reduced to as low as 30 cm if you set [Wire Overlap] to a low value. For details, consult your dealer.)</p>                                  |
|  <p>Areas which the lawnmower might fall into</p>                | <p>Lay fence around areas which the lawnmower might fall into, such as uneven ground, ponds, pools, driveways, or other areas with differences in height.</p>   |
|   | <p>Do not lay boundary wire so that it intersects on a slope of more than 10° (17%). You can lay boundary wire parallel to a slope of more than 10° (17%) in order to access an area with a slope of less than 10° (17%).</p>                         |
|   | <p>Boundary wire should be laid so that there is no excess wire.</p>  |
|  <p>Radius 30 m</p>   | <p>The lawnmower can detect the signal from the boundary wire within a 30 m radius. If the lawnmower enters a space inside the work area with no boundary wire within a 30 m radius, the signal will not be detected and the lawnmower will stop.</p> |
|  <p>Acute angle</p> <p>Right angle or obtuse angle</p>          | <p>The boundary wire must not be laid with any acute angles. (Angles should be more than 90°.)</p>  |

| Image   | Condition  |
|---|--|
| <p>The image contains two identical diagrams. Each diagram shows a 'Docking station' on the left and a 'Boundary wire of the another robotic lawnmower' on the right. A 'Boundary wire' is also shown near the docking station. Two horizontal arrows indicate distances: one from the docking station to the other lawnmower's boundary wire labeled 'More than 3 m', and another from the docking station to its own boundary wire labeled 'More than 1 m'.</p> | <p>If you want to use an additional robotic lawnmower, the boundary wire must be laid according to the figure on the left.</p> |

## Setting up the lawnmower

When turning the lawnmower on initially, the initial settings and setup wizard will appear. Through the initial settings, you can configure the display language, internal date and time, and create your PIN (Personal Identification Number). Through the setup wizard, you can configure the settings for the mowing operation of your lawnmower.

### NOTE:

- If your dealer already configured the setup wizard, the setup wizard screen is not displayed.

## Turning on the power

After the battery is charged, press the **(On)** button to turn on the lawnmower. The **(On)** button is located on the control panel towards the rear side of the lawnmower.

### ⚠ WARNING

- Do not insert your finger beneath the closed operation panel cover or height adjustment dial cover.

1

**Press the manual STOP button.**  
The control panel cover pops up.

Manual STOP button

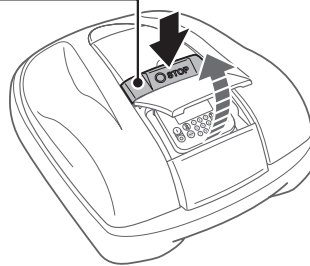

2

**Press the **(On)** button on the control panel.**

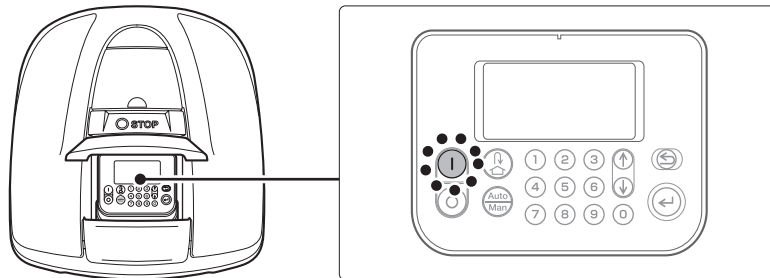

The power turns on, and the initial setup screen on the control panel is displayed.

## Initial settings

When turning the lawnmower on initially, the initial settings will appear to set the display language, internal date and time, and create your PIN (Personal Identification Number).

### ⚠ WARNING

- Make sure to press the manual STOP button before performing the following procedure.

1

Select your preferred language and press the  button.

#### NOTE:

- The factory default setting of the display languages is as follows:  
EAE/EAB/EAS: Set 1  
EAEN: Set 2  
If you want to set other languages, contact your dealer.

#### Set 2

|                  |
|------------------|
| Initial setup    |
| Select language  |
| <b>1.English</b> |
| 2.Svenska        |
| 3.Norsk          |
| 4.Español        |
| 5.Polski         |

#### Set 1

|                  |
|------------------|
| Initial setup    |
| Select language  |
| <b>1.English</b> |
| 2.Deutsch        |
| 3.Français       |
| 4.Italiano       |
| 5.Nederlands     |

#### Set 3

|                  |
|------------------|
| Initial setup    |
| Select language  |
| <b>1.English</b> |
| 2.Dansk          |
| 3.Français       |
| 4.Suomalainen    |
| 5.Čeština        |

2

Enter the date with the format {Day}/{Month}/{Year} and the time in 24-hour format.

|                    |
|--------------------|
| Initial setup      |
| Set date and time  |
| <b>D</b> D/MM/20YY |
| __:__(24h)         |
| OK                 |

3

Select [OK] and press the  button.

|                   |
|-------------------|
| Initial setup     |
| Create a PIN code |
| █                 |
| OK                |

4

Input a PIN using the number buttons.

5

Select [OK] and press the  button.

The message "Initial setup complete" is displayed. If you select [2.Restart initial setup], you can set the initial setup again.

|                         |
|-------------------------|
| Initial setup complete  |
| <b>1.Setup wizard</b>   |
| 2.Restart initial setup |
| Finish                  |

Initial setup is completed. Go to the setup wizard to configure the settings for the mowing operation of your lawnmower.

## ■ Configuring the settings through the setup wizard

The setup wizard will guide you to configure the settings for your mowing operation as follows:

| Menu name               | Usage   | Configuring and testing the settings  |
|-------------------------|---|---|
| [1.Garden layout]       | For configuring the settings related to the layout of the boundary wire. These setting values are referred from the other settings. | - Direction for the lawnmower to dock to the docking station<br>- Length of the boundary wire<br>- Garden size<br>- Existence of narrow passages            |
| [2.Mowing start points] | For configuring the mowing start point settings to enable the lawnmower to start mowing from other areas.                           | - Direction of the mowing start points<br>- Distance of the start points from the docking station<br>- Ratio with which the lawnmower operates in each area |
| [3.Test start points]   | For testing the start points configured in [2.Mowing start points] menu.  | - Testing the setting of each start point   |
| [4.Work timer]          | For setting the work timer to operate the lawnmower according to the schedule.  | - Work day and work time<br>- Seasonal work time  |

### NOTE:

- Before starting the setup wizard, confirm the completion of installing the docking station and laying boundary wire with your dealer.
- Before starting the setup wizard, fill out the DEALER CHECKSHEET at the end of the Owner's Manual.
- If the DEALER CHECKSHEET at the end of Owner's Manual was already filled out by your dealer, refer to it when configuring the settings through the setup wizard.
- After the settings are finished through the setup wizard, you can modify the setting values in the menu settings. For details, see "4. MENU SETTINGS" (☞ page 25).

## 1. Setting the Garden layout

Through this setting, you can configure the information of your garden layout for operating the lawnmower.

1-1

**Select [1.Setup wizard] and press the  button.**

Setup wizard top screen is displayed.

|                                       |
|---------------------------------------|
| Initial setup complete                |
| <b>1.Setup wizard</b>                 |
| 2.Restart initial setup               |
| <input type="button" value="Finish"/> |

1-2

**[1.Garden layout] is selected. Press the  button to configure the garden layout.**

Garden layout screen is displayed.

|                        |
|------------------------|
| Setup wizard           |
| <b>1.Garden layout</b> |
| 2.Mowing start points  |
| 3.Test start points    |
| 4.Work timer           |

1-3

Select [Clockwise(CW)] or [Anticlockwise(ACW)] referring to the layout of your docking station and boundary wire, and press the  $\leftarrow$  button.

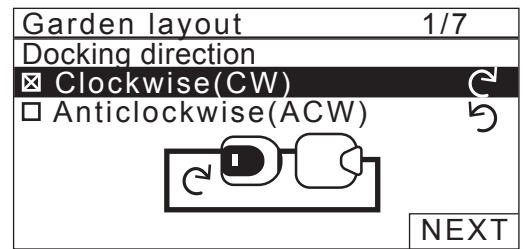

1-4

Select [NEXT] and press the  $\leftarrow$  button.

1-5

Enter the values of the boundary wire length and garden size.

**NOTE:**

- For details on the boundary wire length or garden size, contact your dealer.
- Input the boundary wire length exactly because the values which are automatically configured are associated with the boundary wire length.

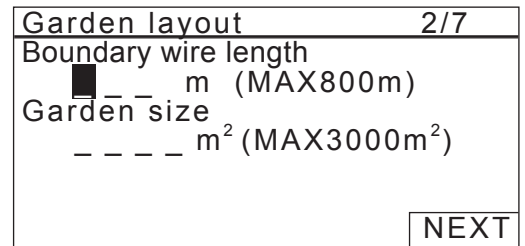

1-6

Select [NEXT] and press the  $\leftarrow$  button.

1-7

Confirm the boundary wire connection of the docking station terminals with the displayed image. Select [OK] and press the  $\leftarrow$  button.

**NOTE:**

- For detail, see "Conditions for installing the docking station" (page 12).

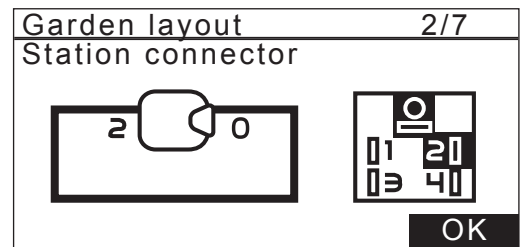

1-8

Select [Yes] or [No] to the question on the narrow passages, and enter the values of the minimum passage width from 100 to 300.

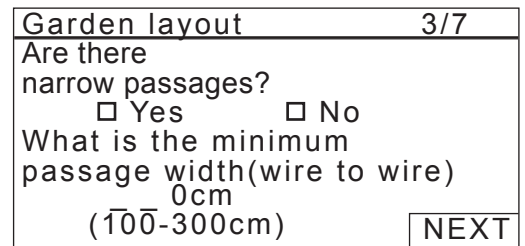

1-9

Select [NEXT] and press the  $\leftarrow$  button. The configuration of garden layout is completed. The setup wizard top screen is displayed and [1.Garden layout] is checked.

**NOTE:**

- If you want to change the settings in this setting, select this menu again. You can modify the settings through the setup wizard.
- Confirm the following settings  
Homing setup - Passage width  
Start point setup - Passage width
- Input the narrow passage of Garden correctly. Be sure to test the settings because the lawnmower automatically set the passage width of departure and the return.



## 2. Setting the mowing start points

Through this setting, you can set the starting point to operate the lawnmower.

If you set the mowing start points and combine them with the settings of work timer, you can effectively mow your garden.

2-1

Select **[2.Mowing start points]** and press the **⏪** button to configure the mowing start points.

Mowing start points screen is displayed.

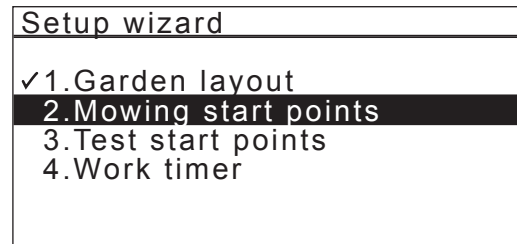

2-2

Select **[Yes]** or **[No]** to the question on the addition of the start points and press the **⏪** button.

If you select **[Yes]**, go to step 2-3.

If you select **[No]**, no start point is added and the setup wizard top screen is displayed.

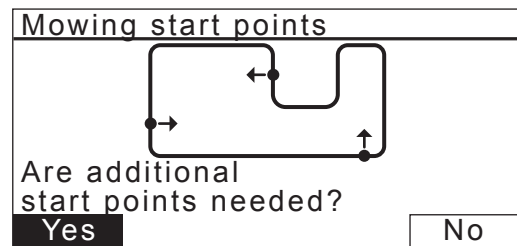

### NOTE:

- When selecting **[No]**, **[2.Mowing start points]** and **[3.Test start points]** are checked on the setup wizard top screen.
- When selecting **[No]**, the lawnmower will always start mowing from the charging station.

2-3

Select **⌚** (Clockwise) or **⌚** (Anticlockwise), enter the values of the distance from the docking station to start cutting, and enter a percentage of the ratio which the lawnmower operates.

Repeat the above operation for the starting points which you want to configure.

| Mowing start points |       |          |   | 4/7 |
|---------------------|-------|----------|---|-----|
| Point               | ⌚ / ⌚ | (0-400m) | m | %   |
| 1                   | □ / □ |          | m | %   |
| 2                   | □ / □ | ---      | m | --- |
| 3                   | □ / □ | ---      | m | --- |
| 4                   | □ / □ | ---      | m | --- |
| 5                   | □ / □ | ---      | m | --- |

### NOTE:

- You can configure the following start points for each model:
  - HRM310: 3 start points
  - HRM520: 5 start points
- Input the percentage of the ratio on the basis of all the garden sizes and the areas of each start point.
  - Even if the lawnmower starts work at the start point, it works in areas other than the set area.

2-4

Select **[NEXT]** and press the **⏪** button.

The configuration of mowing start points is completed.

The setup wizard top screen is displayed and **[2.Mowing start points]** is checked.

### NOTE:

- If you want to change the settings in this setting, select this menu again. You can modify the settings through the setup wizard.

### 3. Testing the Start points

Through this testing, you can check the start points which you added in [2.Mowing start points].



**NOTE:**

- Perform each test when the lawnmower is connected to the docking station.

**3-1** Select [3.Test start points] and press the  button to check the start points.

|                            |  |
|----------------------------|--|
| Setup wizard               |  |
| ✓1.Garden layout           |  |
| ✓2.Mowing start points     |  |
| <b>3.Test start points</b> |  |
| 4.Work timer               |  |

**3-2** Select a start point number and press the  button. The information of the selected start point is displayed.

|                   |   |             |
|-------------------|---|-------------|
| Test start points |   | 5/7         |
| Point             |  /  | (0-400m)    |
| 1                 | <input checked="" type="checkbox"/> / <input type="checkbox"/>  | 8 0 m       |
| 2                 | <input checked="" type="checkbox"/> / <input type="checkbox"/>  | 1 5 0 m     |
| 3                 | <input type="checkbox"/> / <input checked="" type="checkbox"/>  | 6 0 m       |
| 4                 | <input checked="" type="checkbox"/> / <input type="checkbox"/>  | 0 m         |
| 5                 | <input checked="" type="checkbox"/> / <input type="checkbox"/>  | 0 m         |
| 0                 | Home  |             |
|                   |   | <b>NEXT</b> |

**3-3** Confirm the setting information of the selected start points.

|                      |        |
|----------------------|--------|
| Test start points    |        |
| Point1               |        |
| Location             | CW 80m |
| Close cover to start |        |

**3-4** Close the control panel cover. The lawnmower starts towards the selected start point. When the test is correctly finished, the lawnmower rolls slowly from the minimum to the maximum exit angle, and a beep sound is emitted from the lawnmower.

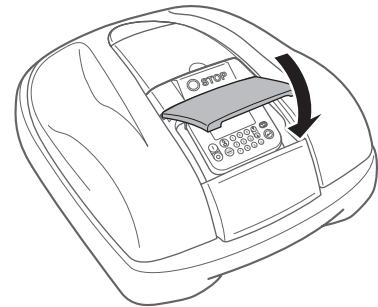

**3-5** Press the manual STOP button. The control panel cover pops up. The message "Test return home" appears on the display.

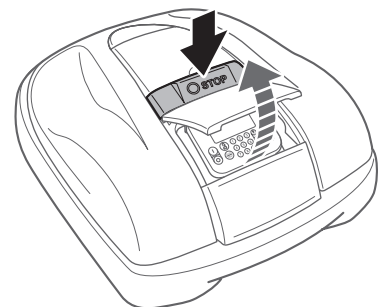

3-6

Select [Yes] or [No] to the question of the test result and press **⏪** button.

If you select [Yes], go to step 3-7.  
If you select [No], the message “Do you want to modify the start point?” is displayed and you can modify the start point settings.

**NOTE:**

- For details on the start point settings, see step 2-3 of “2. Setting the mowing start points” (page 19).

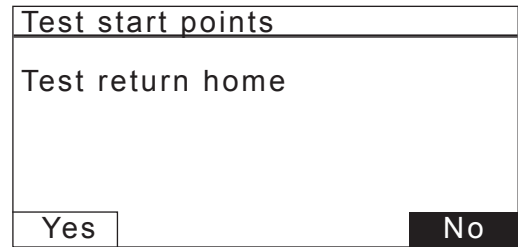

3-7

**Close the control panel cover.**

The lawnmower returns to the docking station.

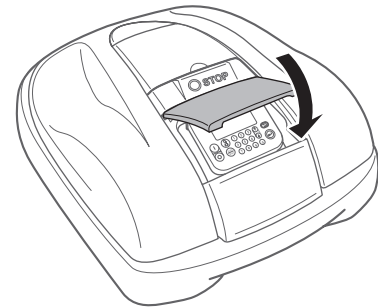

3-8

**When the lawnmower is docked at the docking station, press the manual STOP button.**

The control panel cover pops up.

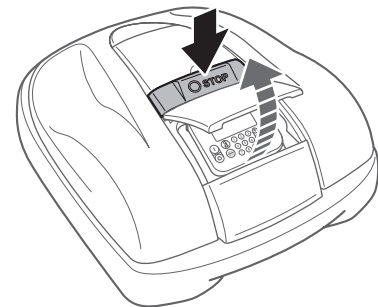

3-9

Select [Yes] or [No] to the question of the test result and press **⏪** button.

If you select [Yes], Mowing start points screen is displayed to configure the start point settings.  
If you select [No], go to step 3-10

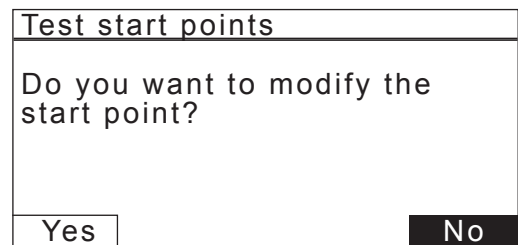

3-10

**After the start point test, select [NEXT] and press the **⏪** button.**

The setup wizard top screen is displayed and [3.Test start points] is checked.

**NOTE:**

- If you want to test the start points once, select this menu again. You can test the start points through the setup wizard.

| Test start points |       | 5/7      |
|-------------------|-------|----------|
| Point             | ☑ / ☐ | (0-400m) |
| 1                 | ☑ / ☐ | 8 0 m    |
| 2                 | ☑ / ☐ | 1 5 0 m  |
| 3                 | ☐ / ☑ | 6 0 m    |
| 4                 | ☑ / ☐ | 0 m      |
| 5                 | ☑ / ☐ | 0 m      |
| 0                 | Home  |          |

**NEXT**

## 4. Setting the work timer

Through this setting, you can configure the work day and work time to operate the lawnmower.

4-1

Select [4.Work timer] and press the  button to configure the work day and work time.

|                        |  |
|------------------------|--|
| Setup wizard           |  |
| ✓1.Garden layout       |  |
| ✓2.Mowing start points |  |
| ✓3.Test start points   |  |
| <b>4.Work timer</b>    |  |
|                        |  |

4-2

Select [1. Auto fill up timer] or [2. Manual setup] and press the  button.

| Menu name              | Description   |
|------------------------|---|
| [1.Auto fill up timer] | For automatically calculating the minimum required dates of the week referring to the boundary wire length and garden size.       |
| [2.Manual setup]       | For manually setting the work day and work time to operate the lawnmower. You can configure the proper settings with your garden. |

|                             |             |
|-----------------------------|-------------|
| Work timer                  | 6/7         |
| Recommended                 | 100hrs/week |
| <b>1.Auto fill up timer</b> |             |
| 2.Manual setup              |             |

If you select [1.Auto fill up timer], go to step 4-3.  
If you select [2.Manual setup], go to step 4-4.

**NOTE:**

- If you don't know the details on the work timer settings, select [1.Auto fill up timer], or contact your dealer.
- For details on the work timer settings, see "4. MENU SETTINGS" (page 25).
- According to the mowing results with the settings which are automatically configured by the system, it may be necessary to adjust the values for operating the lawnmower. If you don't know the details on the settings, contact your dealer.

4-3

Confirm the days which are automatically selected referring to the boundary wire length and garden size. Select [NEXT] and press the  button to proceed to the timer setting screen.

**NOTE:**

- You can select other days to operate the lawnmower.

|                              |   |
|------------------------------|---|
| Work timer                   | 6/7   |
| Minimum days required        | 4   |
| <input type="checkbox"/> All | <input checked="" type="checkbox"/> MON <input checked="" type="checkbox"/> TUE   |
|                              | <input checked="" type="checkbox"/> WED <input checked="" type="checkbox"/> THU <input checked="" type="checkbox"/> FRI |
| <input type="checkbox"/> SAT | <input type="checkbox"/> SUN <b>NEXT</b>  |

4-4

If you select [1.Auto fill up timer] in step 4-2, confirm the days which are automatically configured referring to the boundary wire length and garden size.

If you want to change the work time, select the day and press the ⏪ button to change the work time of the lawnmower.

If you select [2.Manual setup] in step 4-2, select the day and press the ⏪ button to change the work time of the lawnmower.

|     |   |   |    |    |    |
|-----|---|---|----|----|----|
| OK  | 0 | 6 | 12 | 18 | 24 |
| MON |   |   | ■  | ■  |    |
| TUE |   |   | ■  | ■  |    |
| WED |   |   | ■  | ■  |    |
| THU |   |   | ■  | ■  |    |
| FRI |   |   | ■  | ■  |    |
| SAT |   |   |    |    |    |
| SUN |   |   |    |    |    |

4-5

Enter a start time and an end time in 24-hour format for [1]. If necessary, also enter a start time and an end time in 24-hour format for [2].

**NOTE:**

- If selecting [Copy to week] and pressing the ⏪ button, you can copy the settings to the other days. For details on this operation, see "4 MENU SETTINGS" (⌘ page 25).

|              |                       |
|--------------|-----------------------|
| Work timer   | 6/7                   |
| Monday       |                       |
| 1            | From 09:00 - To 12:00 |
| 2            | From 18:00 - To 22:00 |
| Copy to week |                       |

4-6

Press the ⏩ button to return to the previous screen.

4-7

Select [OK] and press the ⏪ button.

4-8

If desired, select start points to be used each day by pressing the ⏪ button to select the start points.

**NOTE:**

- The check boxes which you configured in [2.Mowing start points] are displayed.

|     |                                     |                                     |                                     |   |   |
|-----|-------------------------------------|-------------------------------------|-------------------------------------|---|---|
| OK  | Point 1                             | 2                                   | 3                                   | 4 | 5 |
| MON | <input checked="" type="checkbox"/> | <input checked="" type="checkbox"/> | <input checked="" type="checkbox"/> |   |   |
| TUE | <input checked="" type="checkbox"/> | <input checked="" type="checkbox"/> | <input checked="" type="checkbox"/> |   |   |
| WED | <input checked="" type="checkbox"/> | <input checked="" type="checkbox"/> | <input checked="" type="checkbox"/> |   |   |
| THU | <input checked="" type="checkbox"/> | <input checked="" type="checkbox"/> | <input checked="" type="checkbox"/> |   |   |
| FRI | <input checked="" type="checkbox"/> | <input checked="" type="checkbox"/> | <input checked="" type="checkbox"/> |   |   |
| SAT |                                     |                                     |                                     |   |   |
| SUN |                                     |                                     |                                     |   |   |

4-9

Select [OK] and press the ⏪ button.

4-10

Confirm the achieved and recommended hours per week. Select [Yes] or [No] and press the ⏪ button.

If you select [Yes], go to step 4-11.

If you select [No], go to step 4-8.

|             |             |
|-------------|-------------|
| Work timer  | 6/7         |
| Achieved    | 90hrs/week  |
| Recommended | 100hrs/week |
| Continue?   |             |
| Yes         | No          |

4-11

Select [Yes] or [No] to the question on the seasonal timer and press the ⏪ button.

If you select [Yes] to activate the seasonal timer, go to step 4-12.

If you select [No], go to step 4-14.

**NOTE:**

- The growth speed of a lawn depends on the season. With this function, you can configure the ratio of the mowing time for each season.

|  |     |
|--|-----|
| Work timer   | 7/7 |
| Seasonal timer   |     |
| Timer will change automatically with the season when using this setting. |     |
| Activate?  |     |
| Yes  | No  |

**4-12** Select your region and press the  button.

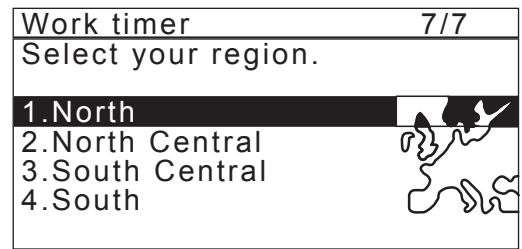



**4-13** Confirming a percentage of each month, select [NEXT] and press the  button.

**NOTE:**

- You can modify the values for operating the lawnmower.
- According to the mowing results with the settings which are automatically configured by the system, it may be necessary to adjust the values for operating the lawnmower. If you don't know the details on the settings, contact your dealer.

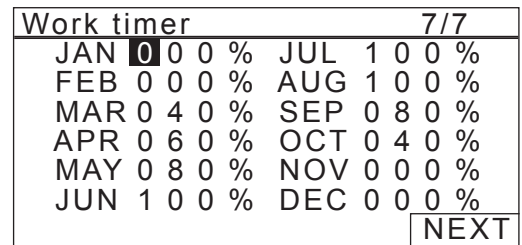
Setup wizard top screen is displayed and [4.Work timer] is checked.



**4-14** Select [Finish] and press the  button. Initial setup complete screen is displayed.

**NOTE:**

- If you want to modify the settings in this menu, select this menu again. You can configure the settings through the setup wizard.

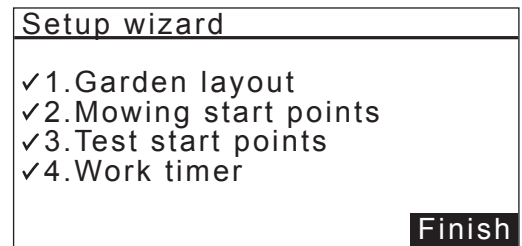

**4-15** Select [Finish] and press the  button. Initial setup is completed and Home screen is displayed.



# 4 MENU SETTINGS

The control panel menus are used to set how the lawnmower operates.

## Menu overview

### NOTE:

- We recommend having your dealer change these settings during installation.

### ● Menu screen

Selecting [Menu] in the home screen and press the  button, Menu screen is displayed as below:

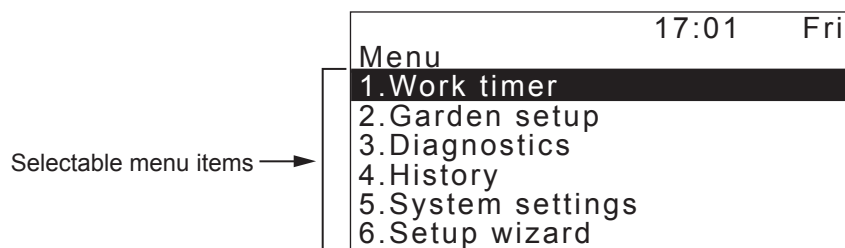

The menu consists of multiple levels of submenus. The uppermost levels are as follows:

| Menu name           | Usage  | See this page for information |
|---------------------|--|-------------------------------|
| [1.Work timer]      | For setting the work day and work time, and selecting the start points.                      | (☰ page 27)                   |
| [2.Garden setup]    | For configuring the lawnmower to operate.  | (☰ page 31)                   |
| [3.Diagnostics]     | For diagnosing the lawnmower.  | (☰ page 43)                   |
| [4.History]         | For viewing operation and error history.   | (☰ page 47)                   |
| [5.System settings] | For configuring system-related settings.   | (☰ page 49)                   |
| [6.Setup wizard]    | For configuring the setting through the set up wizard according to the steps of the screens. | (☰ page 17)                   |

# Full menu diagram

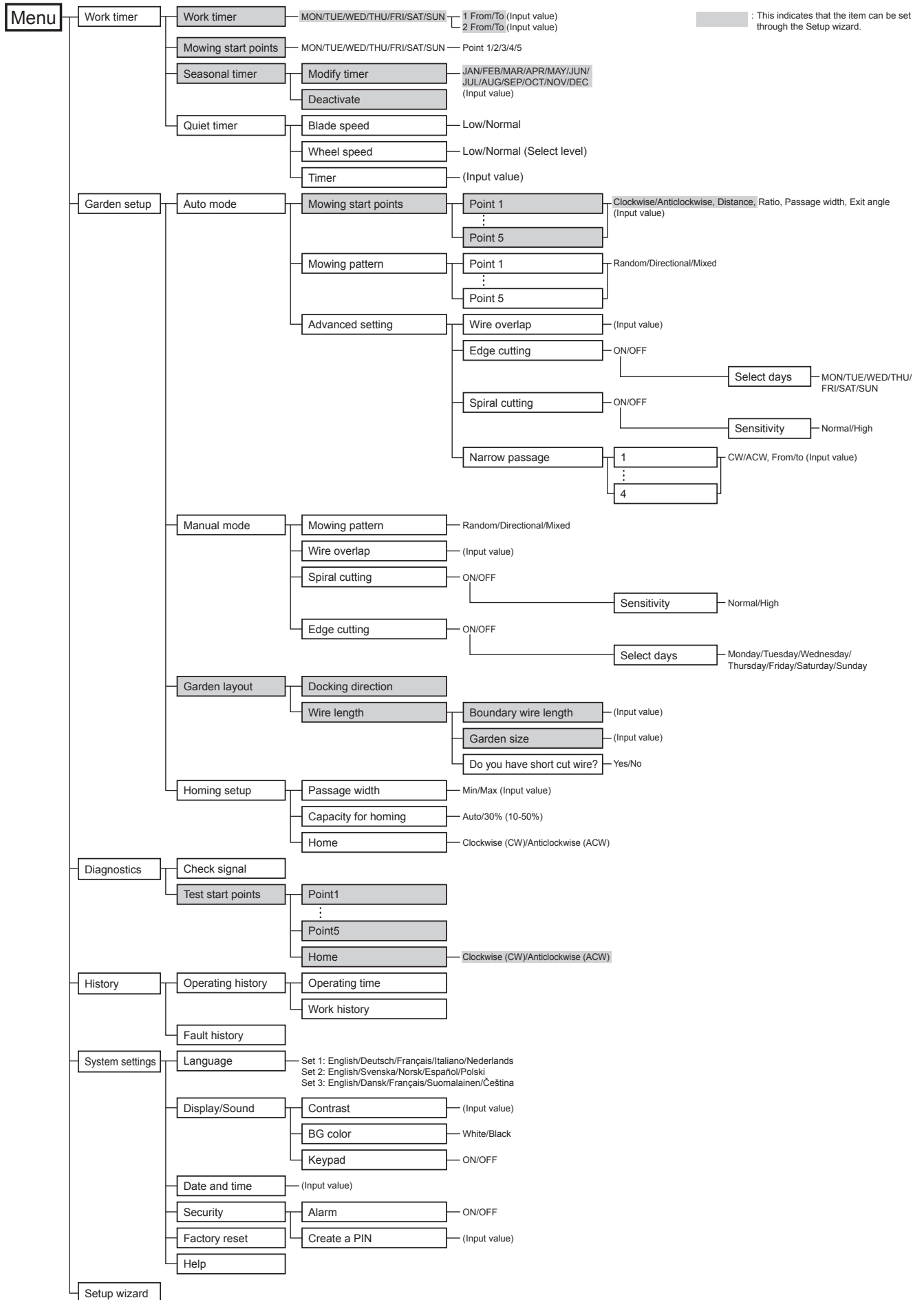



# Setting the work timer

You can set the work day and work time for the lawnmower to operate. You can also specify a specific area for each work time.

## Work timer

You can select the day and time on which you want the lawnmower to operate.



Configure this setting to have the lawnmower operate on specific days and times.

You can set up to two times for operation for one day.

**NOTE:**

- The [Timer 1] cannot be overlapped with the [Timer 2].
- The period of time cannot include "00:00".

- 1 Select the day on which you want the lawnmower to operate.
  - 2 Press the button to proceed to the timer setting screen.
  - 3 Enter a start time and an end time in 24-hour format for [Timer 1] using the number buttons.
  - 4 If necessary, also enter a start time and an end time in 24-hour format for [Timer 2].
- NOTE:**
- If you want to copy the work timer settings to the other days of week, select [Copy to week] and the button.
- 5 Press the button to return to the previous screen.

The percentage which is configured in the seasonal timer is the ratio in which the lawnmower works in a month. For details on the seasonal timer, see "Seasonal timer" (page 29).

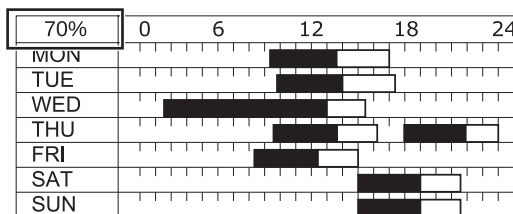

Confirm the period of work time for each day of week.

**NOTE:**

- Black part in the bar is the time in which the lawnmower will work. White part in the bar is the time in which lawnmower will not work. The ratio of black and white parts depends on the settings of seasonal timer. For details on the seasonal timer, see "Seasonal timer" (page 29).

Set the time. →

Work timer

Monday

1 From 00:00 To 00:00

2 From 00:00 To 00:00

Copy to week

Work timer 6/7

Select days to copy

All    MON    TUE

WED    THU    FRI

SAT    SUN

Yes   **No**

If you want to copy the work timer settings to the other days of week, select [Copy to week] and the button.

Select each box of the day which you want to copy and press the button. After adding checks to the boxes, select [Yes] and press the button to copy the settings to the selected days of week.

## Mowing start points

You can set the mowing start points for each day of week.

For example, if you set the following 5 start points in your garden, you enable the lawnmower to reach other areas through narrow passages and mow your garden effectively.

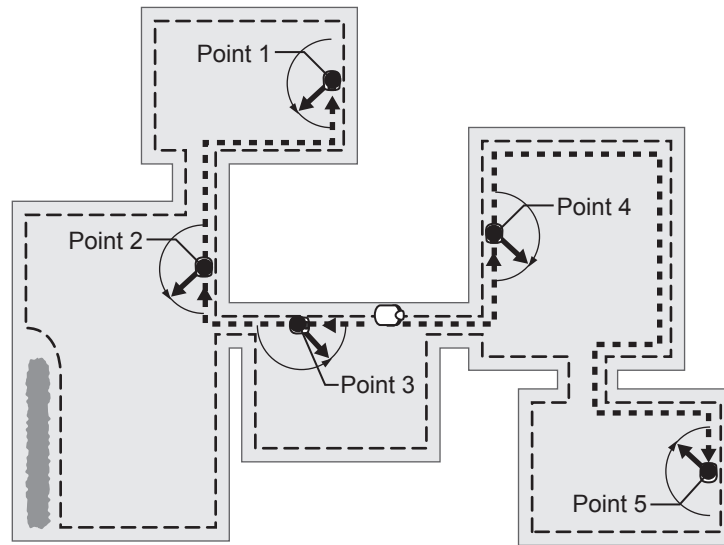
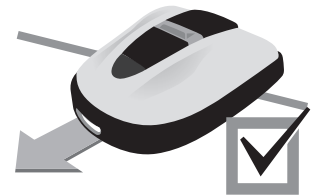

By setting the start points for each day of week, you can effectively operate the lawnmower to mow your garden such as below:

|     | Point 1                             | 2                                   | 3                                   | 4                                   | 5                                   |
|-----|-------------------------------------|-------------------------------------|-------------------------------------|-------------------------------------|-------------------------------------|
| MON | <input checked="" type="checkbox"/> | <input checked="" type="checkbox"/> | <input checked="" type="checkbox"/> | <input type="checkbox"/>            | <input type="checkbox"/>            |
| TUE | <input checked="" type="checkbox"/> | <input checked="" type="checkbox"/> | <input checked="" type="checkbox"/> | <input type="checkbox"/>            | <input type="checkbox"/>            |
| WED | <input checked="" type="checkbox"/> | <input checked="" type="checkbox"/> | <input checked="" type="checkbox"/> | <input type="checkbox"/>            | <input type="checkbox"/>            |
| THU | <input type="checkbox"/>            | <input type="checkbox"/>            | <input checked="" type="checkbox"/> | <input checked="" type="checkbox"/> | <input checked="" type="checkbox"/> |
| FRI | <input type="checkbox"/>            | <input type="checkbox"/>            | <input checked="" type="checkbox"/> | <input checked="" type="checkbox"/> | <input checked="" type="checkbox"/> |
| SAT |                                     |                                     |                                     |                                     |                                     |
| SUN |                                     |                                     |                                     |                                     |                                     |

← From Monday to Wednesday: the lawnmower starts mowing from point 1, point 2, or point 3.



← From Thursday to Friday: the lawnmower starts mowing from point 3, point 4, or point 5.

 **Home screen** → **Menu screen** → **[1. Work timer]** → **[2. Mowing start points]**

Configure this setting to make the lawnmower start mowing from specific start points on specific days of week.

**NOTE:**

- You can configure the following start points for each model:  
HRM310: 3 start points  
HRM520: 5 start points

- 1** Add a check to the box by pressing the  button to select the start points.
- 2** If you want to set the start points in detail, see the setup wizard top screen is displayed and [2. Mowing start points] is checked.
- 3** Press the  button to return to the previous screen.

## Seasonal timer

The growth speed of lawn depends on the season. With this function, you can configure the ratio of the mowing time for each season.

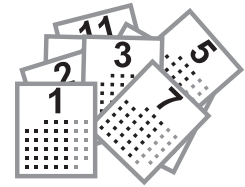

Home screen → **Menu screen** → [1. Work timer] → [3. Seasonal timer] → [1. Modify timer]

Configure this setting to have a percentage of each month of lawnmower operation.

1

Enter a percentage of each month using the number buttons.

2

Select [OK] and press the ⏪ button to return to the previous screen.

| Seasonal timer |         |     |         |
|----------------|---------|-----|---------|
| JAN            | 0 3 0 % | JUL | 0 7 0 % |
| FEB            | 0 3 0 % | AUG | 0 6 0 % |
| MAR            | 0 7 0 % | SEP | 1 0 0 % |
| APR            | 0 9 0 % | OCT | 0 9 0 % |
| MAY            | 1 0 0 % | NOV | 0 7 0 % |
| JUN            | 1 0 0 % | DEC | 0 7 0 % |
|                |         |     | OK      |

Set the ratio of the mowing time for each month.

Home screen → **Menu screen** → [1. Work timer] → [3. Seasonal timer] → [2. Deactivate]

You can deactivate the timer for each season for operating the lawnmower. If the seasonal timer is deactivated, the lawnmower works 100% for each month.

1

Select [OK] and press the ⏪ button to return to the previous screen.





## Quiet timer

You can set the blade speed, wheel speed and timer for operating the lawnmower quietly.



 Home screen → Menu screen → [1. Work timer] → [4. Quiet timer] (“ON” is checked)

Configure this setting to operate the lawnmower with low noise during the period which you configure.

- 1 Select [Blade speed] and press the  button.  
If you want the lawnmower to mow on your lawn quietly, select [Low].
- 2 Press the  button.
- 3 Select [Wheel speed] and configure the wheel speed level with which you want the lawnmower to operate by pressing the up/down arrow buttons.
- 4 Press the  button.
- 5 Select [Timer] and enter a start time and an end time in 24-hour format using the number buttons.
- 6 Press the  button.
- 7 Press the  button to return to the previous screen.

Configure the blade speed of the lawnmower.

Set a start time and an end time for configuring the time for the quiet operation.

|                              |  |
|------------------------------|--|
| 17:01                        | Fri  |
| Quiet timer                  |  |
| Blade speed                  |  |
| <input type="checkbox"/> Low | <input checked="" type="checkbox"/> Normal   |
| Wheel speed                  |  |
| Low                          | <input type="checkbox"/> <input checked="" type="checkbox"/> <input checked="" type="checkbox"/> <input checked="" type="checkbox"/> <input checked="" type="checkbox"/> <input type="checkbox"/> Normal |
| Timer                        |  |
| 00:00                        | - 00:00  |

Configure the wheel speed of the lawnmower.

# Setting the lawnmower operation

## Auto mode

You can set up the lawnmower operation as follows:

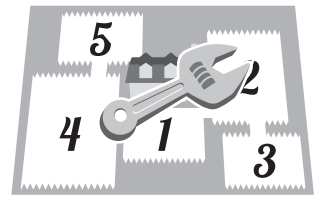

### Setting the angle to turn from the boundary wire

When leaving the boundary wire, set the angle to turn from the boundary wire.

🔍 *Angle settings in [1.Mowing start points] (page 33)*

- Set the angle of departure for when the lawnmower arrives at the position specified by the angle of [1.Mowing start point].

### Setting the distance to the start point

Until the lawnmower reaches a set starting point in an area, it will run without mowing.

🔍 *Distance settings in [1.Mowing start points] (page 33)*

- Sets the distance from the docking station to start cutting.

### Setting the overlap distance on the boundary wire

Set the distance that the lawnmower can cross the boundary wire.

🔍 *[1.Wire Overlap] in [4.Advanced setting] (page 34)*

#### NOTE:

- To have the lawnmower smoothly turn from the boundary wire, the recommended value of the Wire overlap is 20 cm.

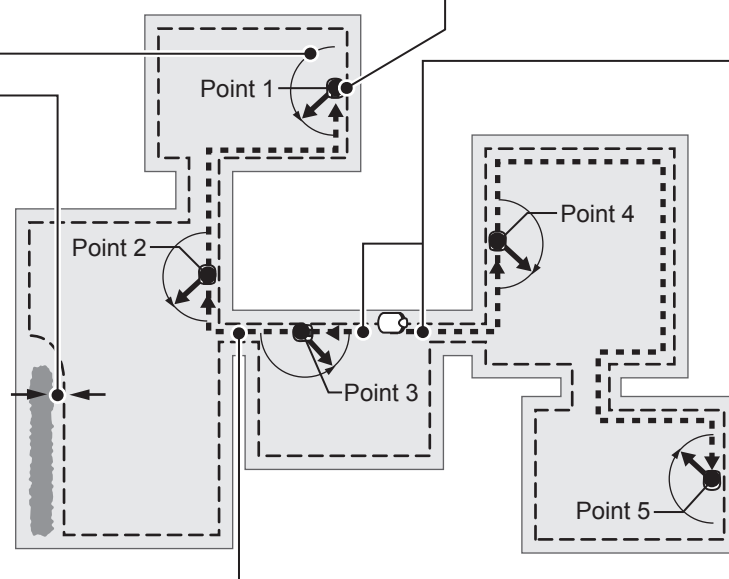

### Setting the starting direction from the docking station

Set whether the lawnmower should travel clockwise or anticlockwise along the boundary wire to reach a set starting point.

🔍 *⌚ (Clockwise) or ⚙️ (Anticlockwise) in [1.Mowing start point] (page 33)*

### Setting the value to reach other areas through the narrow passage

The lawnmower can reach other areas through narrow passages with the following settings:

- Configure the minimum value ("0") of Narrow passage in the Advanced setting. The lawnmower closely follows the boundary wire. This is effective for 5 or more narrow pathways in the garden.
- Configure the value of the narrow passage distance from the docking station. When passing the configured narrow passage, the lawnmower closely follows the boundary wire. This is effective for 4 or fewer narrow pathways in the garden.

🔍 *Width settings in [1.Mowing start points] (page 33)*

🔍 *[4.Narrow passage] in [4.Advanced setting] (page 37)*

#### NOTE:

- [4.Narrow passage] setting is for going toward the starting point. If you want to configure the setting for returning to the docking station, you need to set it in the Homing setup. For details, see "Homing setup" (page 41).

### Setting the operation ratio of each area operation

Set an area operation ratio if you want to mow more frequently from a certain start point.

For example, if you set the ratio for "Point 1" to 30%, the lawnmower will start mowing 3 times out of 10 from "Point 1" and 7 times out of 10 from other start points.

🔍 *Percentage settings in [1.Mowing start points] (page 33)*

#### NOTE:

- You can configure the following start points for each model:  
HRM310: 3 start points  
HRM520: 5 start points

#### NOTE:

- If you want to operate the lawnmower with [Auto mode], see "Operating the lawnmower with the Auto mode." (page 55).

## Distance from the boundary wire when the lawnmower goes toward the mowing start points:

The lawnmower moves between the boundary wire and the specified value at random as it goes toward the mowing start point.

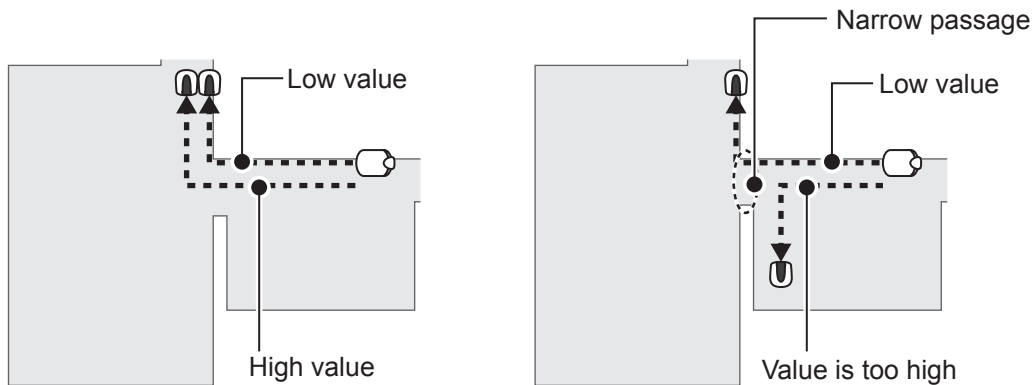

**NOTE:**

- When the value is too high, lawnmower may not pass through narrow passage.

## Passage width sample table

| Setup level | Passage width |
|-------------|---------------|
| 0           | 10 cm         |
| 1           | 25 cm         |
| 2           | 30 cm         |
| 3           | 35 cm         |
| 4           | 40 cm         |
| 5           | 45 cm         |
| 6           | 50 cm         |
| 7           | 60 cm         |
| 8           | 70 cm         |
| 9           | 80 cm         |
| 10          | 90 cm         |
| 11          | 100 cm        |
| 12          | 110 cm        |

**NOTE:**

- The field strength varies depending on the length of the boundary wire. The field becomes weaker with a longer boundary wire, and stronger with a shorter boundary wire.
- When the value is high (by avoiding moving along the same path), you can avoid creating wheel tracks in the grass.
- The numerical values of this table are for reference to return the lawnmower to the docking station along a straight line.
- The numerical values may differ depending on the actual conditions.

## The angle at which the lawnmower deviates from the boundary wire:

The lawnmower travels to this location along the boundary wire, and then turns away from the boundary wire to start mowing.

You can configure the angle (range) at which the lawnmower deviates from the boundary wire when it starts mowing as below:

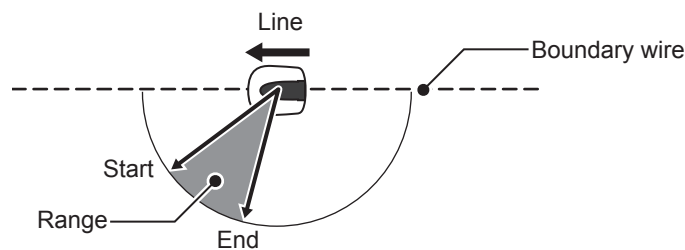

**TIPS** Use the exit angle to let the lawnmower reach the mowing areas directly instead of using long wire exit locations.

## Mowing start points

Home screen → **[2.Garden setup]** → **[1.Auto mode]** → **[1.Mowing start points]** → **[1.Point 1]** to **[5.Point 5]**

The lawnmower travels to this location along the boundary wire, and then turns away from the boundary wire to begin mowing. This allows you to send the lawnmower to an area which is difficult to access.

**TIPS** Don't make the distance value bigger than it needs to be. This will maximise the cutting time.

- 1 Select ⌚ (Clockwise) or ⌚ (Anticlockwise), enter the values of the distance from the docking station to start cutting, and enter a percentage of the ratio which the lawnmower operates.
- 2 Select [NEXT] and press the ⏪ button.
- 3 Enter the values of the width setting and angle, and press the ⏪ button.
- 4 Press the ⏪ button to return to the previous screen.

Set whether the lawnmower should travel clockwise or anticlockwise along the boundary wire to reach a start point.

| Mowing start points |       |          | 1/2     |
|---------------------|-------|----------|---------|
| Point               | ⌚ / ⌚ | (0-400m) |         |
| 1                   | ⌚ / □ | 0 0 0 m  | 0 0 0 % |
| 2                   | ⌚ / □ | 0 0 0 m  | 0 0 0 % |
| 3                   | ⌚ / □ | 0 0 0 m  | 0 0 0 % |
| 4                   | ⌚ / □ | 0 0 0 m  | 0 0 0 % |
| 5                   | ⌚ / □ | 0 0 0 m  | 0 0 0 % |
|                     |       |          | NEXT    |

Sets the distance from the docking station to start cutting.

Set an area operation ratio if you want to mow more frequently from a certain start point.

Sets the minimum and maximum distance between the lawnmower and the boundary wire when following the boundary wire.

| Mowing start points |         |  | 2/2           |
|---------------------|---------|--|---------------|
| Point               | Width   |  | Angle         |
| 1                   | 3 - 6   |  | 5 0 - 1 5 0   |
| 2                   | 3 - 6   |  | 5 0 - 1 5 0   |
| 3                   | 3 - 6   |  | 5 0 - 1 5 0   |
| 4                   | 3 - 6   |  | 5 0 - 1 5 0   |
| 5                   | 3 - 6   |  | 5 0 - 1 5 0   |
| TEST                | (0-1 2) |  | (1 0'-1 7 0') |

When leaving the boundary wire, set the minimum and maximum angle to turn from the boundary wire.



 **Home screen** → **Menu screen** → **[2.Garden setup]** → **[1.Auto mode]** → **[2.Mowing pattern]** → **[1.Point 1] to [5.Point 5]**

You can select from 3 mowing patterns below:

**[Random]**  
With the **[Random]** setting, when the lawnmower detects the boundary wire, it turns at a wide angle. This is the most effective for mowing a large open area of grass. For normal operation, use this setting.

**[Directional]**  
With the **[Directional]** setting, when the lawnmower detects the boundary wire, it turns at a narrow angle. This is used for mowing narrow areas.

**[Mixed]**  
With the **[Mixed]** setting, the lawnmower alternates between the **[Random]** mowing pattern and the **[Directional]** mowing pattern at regular intervals.

- 
- You can adjust how the lawnmower moves while mowing.  
The **[Mixed]** setting is also available. With this setting, the lawnmower alternates between the **Random** mowing pattern and the **Directional** mowing pattern at regular intervals.
- 
- 1

Select **[Random]**, **[Directional]** or **[Mixed]**.
  - 2

Press the **⏪** button.
  - 3

Press the **⏩** button to return to the previous screen.

 **Home screen** → **Menu screen** → **[2.Garden setup]** → **[1.Auto mode]** → **[3.Advanced setting]** → **[1.Wire overlap]**

- 
- When the lawnmower detects the boundary wire, it can slightly cross the boundary to mow the outer edges of the mowing area. You can adjust how far it crosses the boundary wire.
- 
- 1

Enter a value from 20 to 45.
  - 2

Press the **⏪** button.

**NOTE:**

- It is better to use default 20 cm setting for smoothly turning on the boundary wire.

---



**Home screen** → **Menu screen** → **[2.Garden setup]** → **[1.Auto mode]** → **[3.Advanced setting]** → **[2.Edge cutting]**

With this function, you can mow the unmown area along the boundary wire.

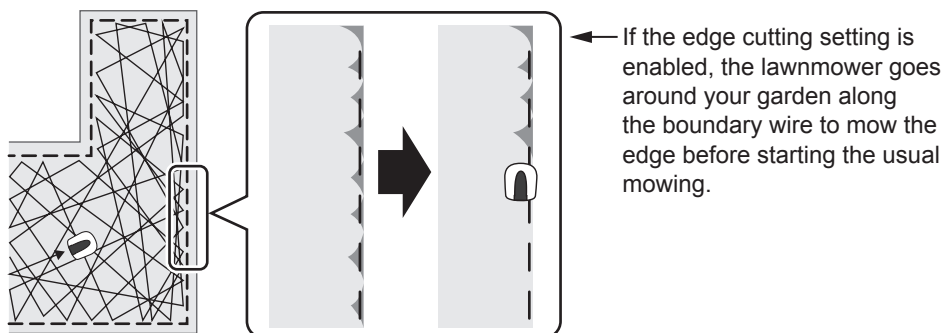

If you set this function on, the lawnmower mows along the boundary wire when the work timer starts for the first time on selected day(s). You can also configure the day(s) of the week on which you want the lawnmower to mow along the boundary wire (2 days per week maximum).

1

**Select [ON] or [OFF] for configuring the edge cutting, and press the  button.**

If select [ON], go to step2. The unmown part along the boundary wire will be neatly-mowed.

If select [OFF], you will return to the previous screen. You can operate the lawnmower normally without using the battery capacity for this feature.

2

**Select the day of the week on which you want the lawnmower to run with the edge cutting function, and press the  button.**

3

**Select [Finish] and press the  button.**

 **Home screen** → **Menu screen** → **[2.Garden setup]** → **[1.Auto mode]** → **[3.Advanced setting]** → **[3.Spiral cutting]**

With this function, the lawnmower can be focused on mowing the area where the lawn is not completely mown, or the growth speed of the lawn is fast.

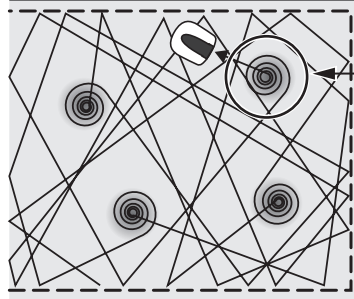

The lawnmower detects the dense area and mow there spirally.

With this function, you can concentrate the lawnmower on mowing the dense area of lawn during the normal operation.

1

**Select [ON] or [OFF] for configuring the spiral cutting, and press the ⏪ button.**

If you select [ON], go to step 2. The lawnmower can be focused on mowing the area where the lawn is not completely mown, or the growth speed of the lawn is fast. If you select [OFF], You will return to the previous screen. You can operate the lawnmower normally without using the battery capacity for this feature.

2

**Select [Normal] or [High] for configuring the sensitivity of detecting the density of lawn, and press the ⏪ button.**

3

**Select [Finish] and press the ⏪ button.**

Menu screen  
 Home screen → [2.Garden setup] → [1.Auto mode] →  
 [3.Advanced setting] → [4.Narrow passage]

If there are narrow passages on your garden, you can configure the settings of the narrow passages to let the lawnmower pass through them toward the starting point.

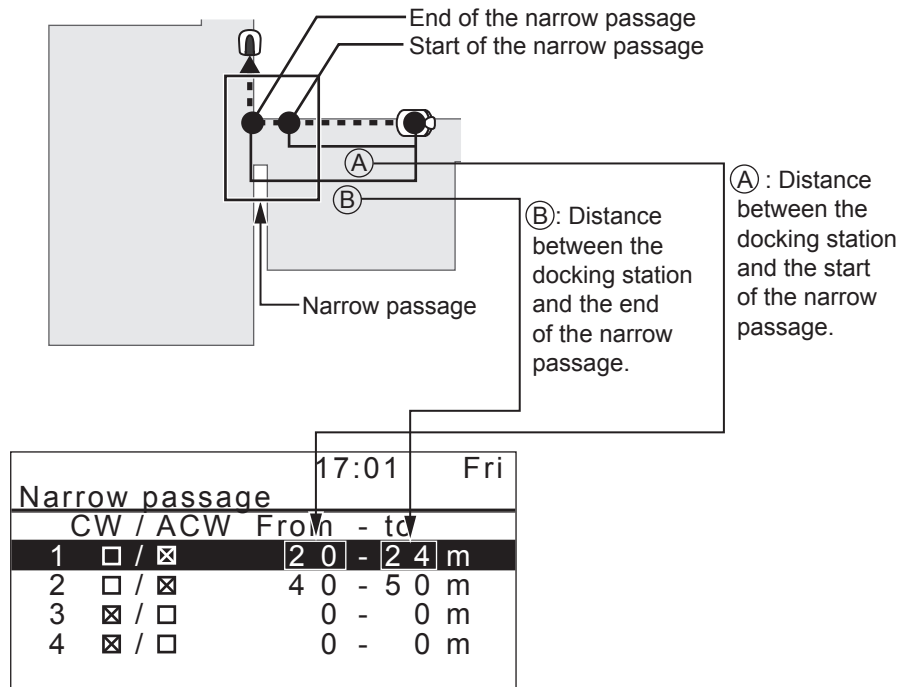

Configure the distance of the narrow passages from the docking station to let the lawnmower pass through them.

#### NOTE:

- Specify the distance from start to end of each narrow passage from the docking station.
- This setting is for going toward the starting point. If you want to configure the setting for returning to the docking station, you need to set it in the Homing setup. For details, see "Homing setup" (page 41).

1

Select a number from 1 to 4 which you want to configure and press the  $\leftarrow$  button.

2

Select CW or ACW and press the  $\leftarrow$  button. And enter the values of the distance from start to end of each narrow passage and press the  $\leftarrow$  button.

3

Press the  $\leftarrow$  button.

4

Press the  $\rightarrow$  button to return to the previous screen.

## Manual mode

With this function, you can configure the lawnmower to mow without the work timer function.



### NOTE:

- If you want to operate the lawnmower with [Manual mode], see “Operating the lawnmower with the Manual mode” (page 72)

## Mowing pattern

You can select from 3 mowing patterns below:

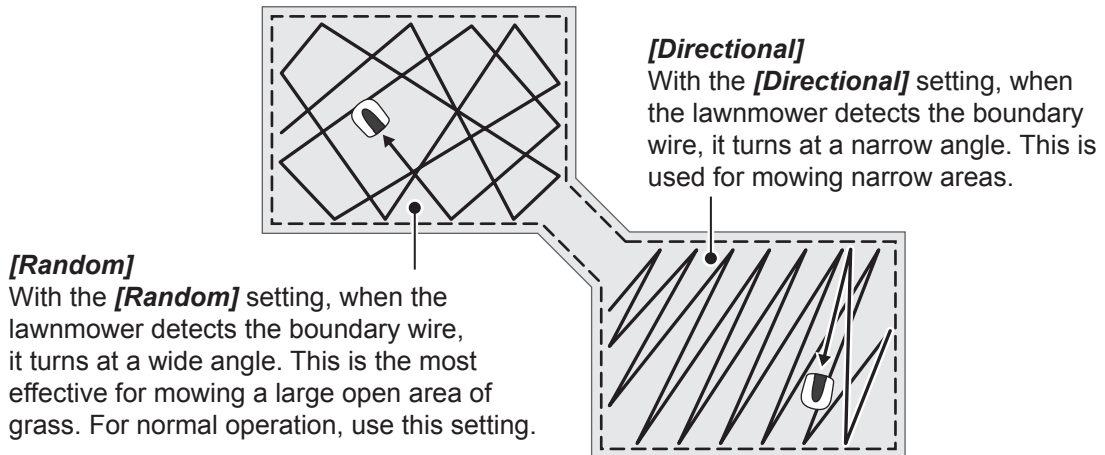

**[Mixed]**  
With the **[Mixed]** setting, the lawnmower alternates between the **[Random]** mowing pattern and the **[Directional]** mowing pattern at regular intervals.

## Spiral cutting:

With this function, the lawnmower can be focused on mowing the area where the lawn is not completely mown, or the growth speed of the lawn is fast.

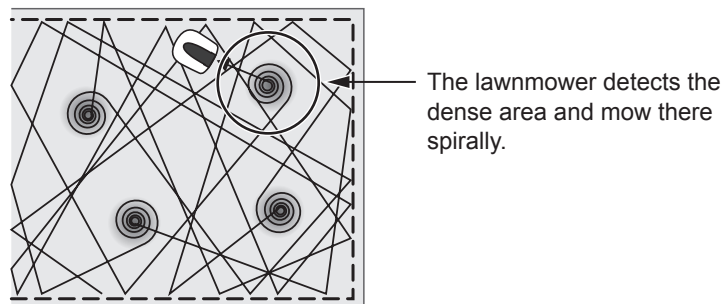

## Edge cutting:

With this function, you can mow the unmown area along the boundary wire.

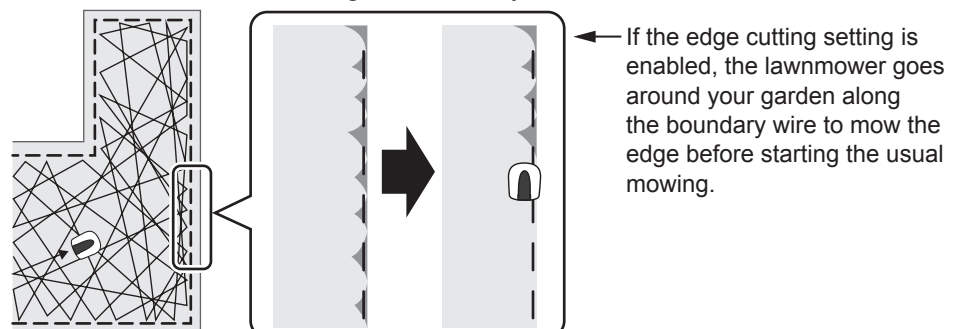



Menu screen  
**Home screen → [2. Garden setup] → [2. Manual mode]**

You can adjust how the lawnmower moves while mowing.

**NOTE:**

- If you want the lawnmower to operate with the manual mode, change the operating mode by pressing the button. For details, see "5 USAGE" (page 53).
- Among the mowing pattern settings, the [Mixed] setting is also available. With this setting, the lawnmower alternates between the Random mowing pattern and the Directional mowing pattern at regular intervals.

- 1 Select [Mowing pattern] and press the .
- 2 Select [Random], [Directional] or [Mixed] for configuring the mowing pattern, and press the .
- 3 Select [Wire overlap] and enter the values of the wire overlap from 20 to 45, and press the .
- 4 Select [NEXT] and press the .
- 5 Select [ON] or [OFF] for configuring the spiral cutting, and press the .
- 6 Select [NEXT] and press the . If you select [ON], go to step 7. If you select [OFF], go to step 9.
- 7 Select [Normal] or [High] for configuring the sensitivity, and press the .
- 8 Select [NEXT] and press the .
- 9 Select [ON] or [OFF] for configuring the edge cutting, and press the . If you select [ON], go to step 10. If you select [OFF], go to step 11.
- 10 Select the day of the week on which you want the lawnmower to run with the edge cutting function, and press the .
- 11 Select [Finish] and press the .

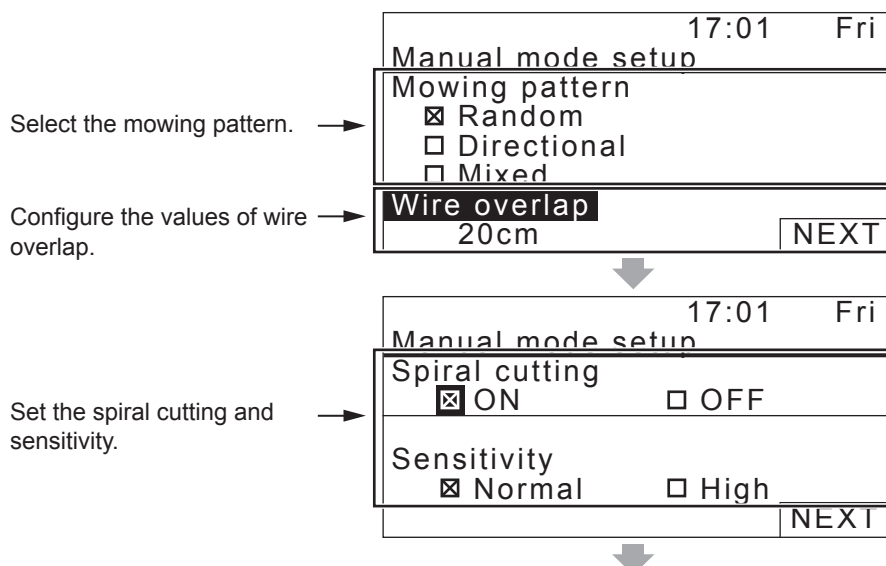

Set the edge cutting and select the days on which you want the lawnmower to operate with this function.

|   |                              |                              |
|---|------------------------------|------------------------------|
| 17:01                                   |                              | Fri                          |
| Manual mode setup                       |                              |                              |
| Edge cutting                            |                              |                              |
| <input checked="" type="checkbox"/> ON  | <input type="checkbox"/> OFF |                              |
| Select days                             |                              |                              |
| <input checked="" type="checkbox"/> MON | <input type="checkbox"/> TUE | <input type="checkbox"/> WED |
| <input checked="" type="checkbox"/> THU | <input type="checkbox"/> FRI |                              |
| <input type="checkbox"/> SAT            | <input type="checkbox"/> SUN | Finish                       |

## Garden layout

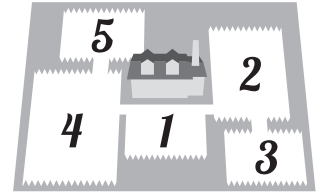

 **Home screen** → Menu screen → **[2.Garden setup]** → **[3.Garden layout]** → **[1.Docking direction]**

You can set the direction for the lawnmower to move in relation to the docking station.

**NOTE:**

- Before configuring the settings, confirm the completion of installing the docking station and laying boundary wire with your dealer.
- For details on the boundary wire connection of the docking station terminals, see “Conditions for installing the docking station” (☞ page 12).

- 1 Select **[Clockwise(CW)]** or **[Anticlockwise(ACW)]**.
- 2 Press the **←** button.

 **Home screen** → Menu screen → **[2.Garden setup]** → **[3.Garden layout]** → **[2.Wire length...]**

You can configure the information of your garden layout to operate the lawnmower.

**NOTE:**

- Before configuring the settings, confirm the completion of installing the docking station and laying boundary wire with your dealer.
- If the DEALER CHECKSHEET at the end of Owner’s Manual was already filled out by your dealer, refer to it when configuring the settings.

- 1 Enter the values of the boundary wire length and garden size, and select **[Yes]** or **[No]** to the question about the short cut wire. See “Other setting item information” (☞ page 81).

**NOTE:**

- Select **[No]** to the question about the short cut wire if you will install the docking station near a corner.
- Have your dealer install the short cut wire.

- 2 Press the **←** button.

## ■ Homing setup

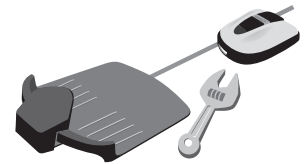

 Home screen → <sup>Menu screen</sup> [2. Garden setup] → [4. Homing setup] → [1. Passage width]

You can set where the lawnmower moves in relation to the boundary wire as it goes back to the docking station.

### NOTE:

- This setting must be set to a value lower or equal than the lowest width value that is set for any mowing start point setting. For details on the mowing start point settings, see “Mowing start point” (📖 page 33).

Passage width sample table

| Setup level | Passage width |
|-------------|---------------|
| 0           | 10 cm         |
| 1           | 25 cm         |
| 2           | 30 cm         |
| 3           | 35 cm         |
| 4           | 40 cm         |
| 5           | 45 cm         |
| 6           | 50 cm         |
| 7           | 60 cm         |
| 8           | 70 cm         |
| 9           | 80 cm         |
| 10          | 90 cm         |

- The field strength varies depending on the length of the boundary wire. The field becomes weaker with a longer boundary wire, and stronger with a shorter boundary wire.
- When the value is high (by avoiding moving along the same path), you can avoid creating wheel tracks in the grass.
- The numerical values of this table are for reference to return the lawnmower to the docking station along a straight line.
- The numerical values may differ depending on the actual conditions.

**TIPS** Use as big passage width as possible so to reach the area quickly.

1

Enter a number setting.

2

Press the  button.



Menu screen

Home screen → [2.Garden setup] → [4.Homing setup] → [2.Capacity for homing]

You can set the percentage of remaining amount of the battery when the lawnmower starts to go back to the docking station.

**TIPS** The longer the wire is, the higher this value should be.

- 1 **Select [Auto] or Enter a percentage of battery residual capacity.**  
The range of the percentage of battery residual capacity is 10 – 50%.
- 2 **Press the ⏪ button.**



Menu screen

Home screen → [2.Garden setup] → [4.Homing setup] → [0.Home]

You can test if the lawnmower will correctly return to the docking station.

**NOTE:**

- Perform this test when the lawnmower is not connected to the docking station.

**TIPS** Test returning through the different passages.

- 1 **Select [Clockwise(CW ⤴)] or [Anticlockwise(ACW ⤵)].**
- 2 **Press the ⏪ button.**
- 3 **Close the control panel cover.**  
The lawnmower returns to the docking station.
- 4 **When the lawnmower is docked at the docking station, press the manual STOP button.**  
The control panel cover pops up.  
The message “Test finished” appears on the display.







## ■ Checking the system

### ■ Check signal

You can check if the boundary wire signal is correctly reaching the lawnmower and confirm how strong the signal is.



 Home screen → Menu screen → **[3.Diagnostics]** → **[1.Check signal]**

| Signal level indication   | Signal strength   |
|---|---|
| Lv0   | No loop signal  |
| Lv1   | Weak  |
|  |  |
| Lv5   | Moderate  |
|  |  |
| Lv10  | Strong  |

## ■ Test start points

You can check whether the lawnmower can correctly return to the docking station, and whether it can reach each start points according to settings.

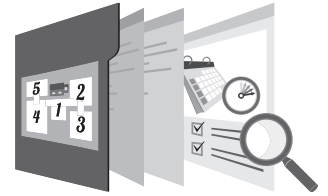

 **Home screen** → <sup>Menu screen</sup> **[3.Diagnostics]** → **[2.Test start points]** → **[1.Point1] to [5.Point5]**



You can test if the lawnmower will correctly go to a specific start point.

HRM310: Start point 1 to 3

HRM520: Start point 1 to 5

**NOTE:**

- Perform this test when the lawnmower is connected to the docking station.

- 1** Select a point from 1 to 5 which you want to test and press the  button.
- 2** Confirm the value of the selected point settings.
- 3** Select **[Yes]** and press the  button.
- 4** **Close the control panel cover.**  
The lawnmower starts to the selected start point.  
When the test is correctly finished, the lawnmower rolls slowly from side to side showing the minimum and maximum exit angle, and a beep sound is emitted from the lawnmower.
- 5** **Press the manual STOP button.**  
The control panel cover pops up.  
The message “Do you want to modify the start point?” appears on the display.
- 6** **Select [Yes] or [No] to the question and press  button.**  
If you select [Yes], Mowing start point screen appears. You can modify the settings of the tested start point.  
If you select [No], the previous screen appears.

**NOTE:**

- For details on the start point settings, see “Setting the mowing start points” (📖 page 19).



Home screen → **Menu screen** → **[3.Diagonostics]** → **[2.Test start points]** → **[0.Home]**

You can test if the lawnmower will correctly return to the docking station.

**NOTE:**

- Perform this test when the lawnmower is not connected to the docking station.

1

Select **[Clockwise(CW)]** or **[Anticlockwise(ACW)]**.

2

Press the **⊖** button.

3

**Close the control panel cover.**  
The lawnmower returns to the docking station.

4

**When the lawnmower is docked at the docking station, press the manual STOP button.**

The control panel cover pops up.  
The message "Do you want to modify the homing setup?" appears on the display.

5

**Select [Yes] or [No] to the question and press ⊖ button.**

If you select [Yes], Homing setup screen is displayed. You can modify the homing settings.  
If you select [No], the previous screen is displayed.

**NOTE:**

- For details on the homing settings, see "Setting how the lawnmower returns to the docking station" (☞ page 12).

## Viewing history

### Operation history

You can check the cumulative time that the lawnmower has operated and recharged.

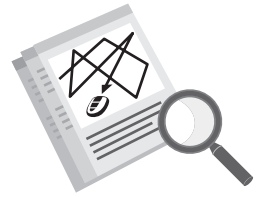

**Home screen** → Menu screen → **[4.History]** → **[1.Operating history]** → **[1.Operating time]**

You can view how long the lawnmower has mowed, and how long the lawnmower has charged.

1

Check the history.

2

Press the ⏪ button to return to the previous screen.

This is the total cutting time. →

This is the total charging time. →

|                       |           |     |
|-----------------------|-----------|-----|
|                       | 17:01     | Fri |
| <b>Operating time</b> |           |     |
| <b>Cutting</b>        | 180h55min |     |
| <b>Charging</b>       | 141h37min |     |
|                       |           |     |

## Work history

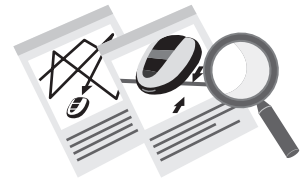

Home screen → <sup>Menu screen</sup> [4.History] → [1.Operating history] → [2.Work history]

You can view the lawnmower's cutting history (when the lawnmower was mowing), return history (when the lawnmower was returning to the docking station), and charge history (when the lawnmower was charging).

### NOTE:

- Only the history of auto mode is displayed.

1

Check the history by pressing the up/down arrow buttons to scroll the menu.



2

Press the  button to return to the previous screen.

Each time the lawnmower leaves the docking station after recharging, a new entry is created in the history list. The most recent entry is [01], and the oldest entry is [10].

| Work history    |   | 17:01     |   | Fri |
|-----------------|---|-----------|---|-----|
| Cutting history |   |           |   |     |
| 01:22 min       | 1 | 06:43 min | 1 |     |
| 02:60 min       | 1 | 07:67 min | 2 |     |
| 03:53 min       | — | 08:33 min | 3 |     |
| 04:12 min       | 3 | 09:59 min | — |     |
| 05:62 min       | 1 | 10:45 min | 1 |     |

The start point number where the lawnmower was mowing is displayed.

This mark indicates that there is another page. Use the  /  buttons to change pages.

| Work history   |           | 17:01 |  | Fri |
|----------------|-----------|-------|--|-----|
| Charge history |           |       |  |     |
| 01:32 min      | 06:43 min |       |  |     |
| 02:66 min      | 07:77 min |       |  |     |
| 03:53 min      | 08:33 min |       |  |     |
| 04:42 min      | 09:59 min |       |  |     |
| 05:71 min      | 10:45 min |       |  |     |

The time for the most recent charge history entry is displayed first.

## Fault history

You can view the lawnmower's fault history (when a fault occurred).

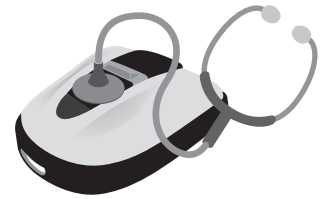

Home screen → <sup>Menu screen</sup> [4.History] → [2.Fault history]

The history of errors that have occurred are logged.

### NOTE:

- If the same error occurs repeatedly many times on the same day, only the time when the first error occurred is saved.

1

Select fault history entry by using the up/down arrow buttons.

2

Press the button. Fault information is displayed. For details on faults, see "6 TROUBLESHOOTING" (page 60).

3

Press the button to return to the previous screen.

The most recent fault error entry is displayed first. Press the button for more information.

| Fault history |       |          |       | 17:01 | Fri |
|---------------|-------|----------|-------|-------|-----|
| 1.            | 3A036 | 28.08.12 | 11:23 |       |     |
| 2.            | 3A024 | 28.08.12 | 10:58 |       |     |
| 3.            | 3A022 | 28.08.12 | 10:42 |       |     |
| 4.            | 3A013 | 28.08.12 | 10:38 |       |     |
| 5.            | -     |          |       |       |     |
| 6.            | -     |          |       |       |     |

This mark indicates that there is another page. Use the / buttons to change pages.

Fault information and the time of the fault are displayed.

| Fault history    |  |  |  | 17:01 | Fri |
|------------------|--|--|--|-------|-----|
| 03:Lift sensor   |  |  |  |       |     |
| Fault            |  |  |  |       |     |
| 28.08.2014 10:42 |  |  |  |       |     |

## Setting the system

### Language

You can set the menus of the display to your preferred language.



 **Home screen** → <sup>Menu screen</sup> **[5.System settings]** → **[1.Language]**

Select the language shown in the display from among 5 languages.

#### NOTE:

- If you want to set other languages, contact your dealer.

1

Select your preferred language.

2

Press the  button.

3

Press the  button to return to the previous screen.

### Display/Sound



 **Home screen** → <sup>Menu screen</sup> **[5.System settings]** → **[2.Display/Sound]** → **[Contrast]**

You can set the contrast of the control panel display.

1

Change the contrast level by pressing the up/down arrow buttons.

2

Press the  button.

3

Press the  button to return to the previous screen.

 **Home screen** → <sup>Menu screen</sup> **[5.System settings]** → **[2.Display/Sound]** → **[BG color]**

You can set the background color of the control panel display.

1

Select [White] or [Black] by pressing the up/down arrow buttons.

2

Press the  button.

3

Press the  button to return to the previous screen.

 **Home screen** → <sup>Menu screen</sup> **[5.System settings]** → **[2.Display/Sound]** → **[Keypad]**

You can set whether or not a beep sound is emitted when you press control panel buttons.

- 1 Select [ON] or [OFF] by pressing the up/down arrow buttons.
- 2 Press the ⏪ button.
- 3 Press the ⏩ button to return to the previous screen.

## ■ Date and Time

You can set the internal date and time for the lawnmower.



 **Home screen** → <sup>Menu screen</sup> **[5.System settings]** → **[3.Date and Time]**

Set the date and time for the lawnmower. The timer operates based on this date and time setting.

- 1 Enter the date with the format {Day}/{Month}/{Year} and the time in 24-hour format using the number buttons.
- 2 Press the ⏪ button.
- 3 Press the ⏩ button to return to the previous screen.



## Security

Security settings are used to prevent the lawnmower from being operated by other people.



Home screen → <sup>Menu screen</sup> [5. System settings] → [4. Security] → [1. Alarm]

### NOTE:

- Before selecting [1. Alarm], you will need to input your PIN.

This setting enables or disables the alarm. When set to [OFF], all alarms other than the alarm before the blades start moving are disabled.

### NOTE:

- The [OFF] setting also disables the security alarm that is triggered when the incorrect PIN (Personal Identification Number) is entered 3 times in a row.

1

Select [ON].

2

Press the button.

### NOTE:

- To disable this function, select [OFF].

3

Press the button to return to the previous screen.

Home screen → <sup>Menu screen</sup> [5. System settings] → [4. Security] → [2. Create a PIN]

### NOTE:

- Before selecting [2. Create a PIN], you will need to input your PIN.

You can modify the PIN used for unlocking the control panel menus. Make sure to create the PIN to prevent theft of the lawnmower, unauthorized access, etc.

1

Input a new PIN using the number buttons.

2

Press the button. The message "Activated" is displayed.

3

Press the button to return to the previous screen.

### NOTE:

- Write down your PIN in the space provided. See "DEALER CHECKSHEET" (page 80). If you forget your PIN, contact your dealer.

## Factory reset

You can reset all settings to the factory defaults.





 **Home screen** → Menu screen → **[5.System settings]** → **[5.Factory reset]**

Execute this command to revert all settings to their factory defaults.

**NOTE:**

- This command will not reset the history of the lawnmower (working and fault history). This only resets the settings of the lawnmower.
- Consult your dealer before executing this command.

- 1** Input your PIN and press the  button.
- 2** Select [Yes].
- 3** Press the  button. After the message "Activated" is displayed, the power turns off.

## Help

You can get the information of the lawnmower such as the model name, frame serial number, and software version.



 **Home screen** → Menu screen → **[5.System settings]** → **[6.Help]**

|                       |                     |                                    |
|-----------------------|---------------------|------------------------------------|
| 17:01                 | Fri                 |                                    |
| Help                  |                     |                                    |
| Honda Power Equipment |                     |                                    |
| Miimo                 | :HRM520             | ← This is the model name.          |
|                       | :MBAF-1000001       | ← This is the frame serial number. |
| Software version      |                     |                                    |
|                       | Main ECU : 1.0.0    |                                    |
|                       | Display ECU : 1.0.0 |                                    |

This is the software version. →

**NOTE:**

- If the Frame number is "0000000", contact your dealer.

# 5 USAGE

## Checking the mowing area

Before operating the lawnmower, ensure the mowing area is free of pets and foreign objects.

Turn off the lawnmower before removing any foreign objects.

### CAUTION:

- If there are any holes (such as rabbit holes, etc.) in the work area, fill them in so that the work area is level. Periodically check the work area for holes.



Also confirm that the height of the grass is 65 mm or less.

### NOTE:

- Adjust the height of the blades to mow the grass within 5 mm. For details on how to adjust the height of the blades, see "Adjusting the height of the blades" (☞ page 57).

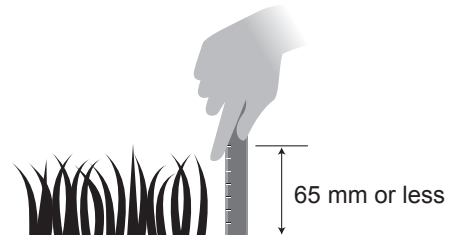

If the grass is taller than 65 mm, cut the grass using a standard lawnmower.

## Connecting to a power source

Follow the steps below when connecting to a power source.

Follow these steps in reverse when disconnecting from a power source.

For details on moving the transformer or changing to a different power outlet, contact your dealer.

### NOTE:

- Connect the station only to a supply circuit protected by a residual current device (RCD) with a tripping current of not more than 30 mA.

- 1 Remove the connector cover from the station.

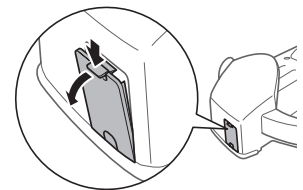

- 2 Connect the power cord connector to the station's internal connector.

### NOTE:

- When disconnecting the connectors, make sure to lift the clip.

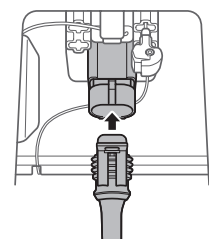

- 3 Attach the connector cover to the station.  
(The power cord and boundary wire should go through the notch in the connector cover.)

- 4 Connect the power cord and the transformer connectors.

### NOTE:

- When disconnecting the connectors, make sure to lift the clip.

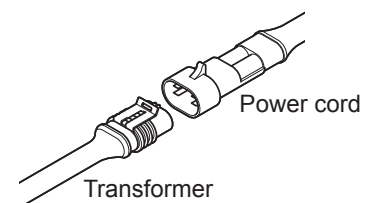

5

**Connect the transformer plug to a power outlet with the designated voltage.**

Power outlet voltage for the EAE, EAEN and EAS types: AC 230 V  
 Power outlet voltage for the EAB type: AC 240 V

## Checking the lawnmower

Before operation, check to make sure that it is connected all the way into the docking station.

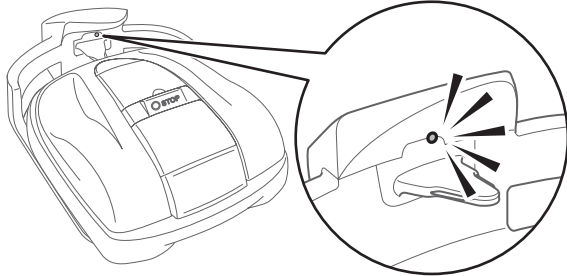

The light above the charging plug changes as follows:

| Color            | Description   |
|------------------|---|
| Green            | The docking station signal setting is correct.  |
| Green (blinking) | The boundary wire is too long.  |
| Amber            | The lawnmower is correctly connected to the docking station.  |
| Amber (blinking) | A signal problem—such as the boundary wire becoming disconnected or cut—has occurred. Contact your dealer.  |
| Red              | Contact your dealer.  |
| Off              | Confirm the connection with the power cord. If the docking station is correctly connected with the power cord, a power failure has occurred. Contact your dealer. |

**NOTE:**

- If the lawnmower is not correctly connected to the docking station, the battery cannot recharge.
- Do not touch the recharging connector. If you touch it, you may become injured.

## Turning on / off the power

### Turning on the power

After the battery is charged, press the **(I)** (On) button to turn on the lawnmower. The **(I)** (On) button is located on the control panel at the rear side of the lawnmower.

**⚠ WARNING**

- Do not insert your finger beneath the closed operation panel cover or height adjustment dial cover.
- When stopping the lawnmower, approach it from the back. Approaching it from the front or sides may lead to unintended contact with the lawnmower, and you may fall over it when the lawnmower begins to move.

1

**Press the manual STOP button.**  
 The control panel cover pops up.

2

**Press the **(I)** (On) button on the control panel.**

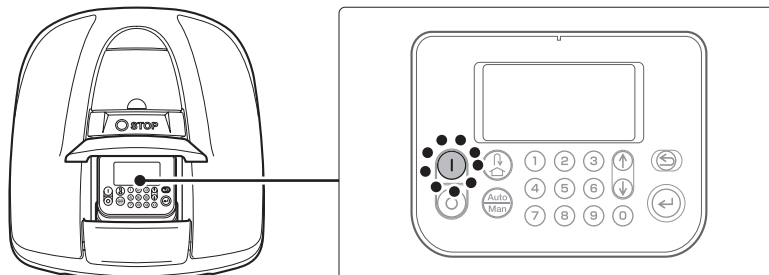

The power turns on, and the startup screen on the control panel is displayed.

## ● Turning off the power

- 1 **Press the manual STOP button.**  
The control panel cover pops up.

- 2 **Press the ⏻ (Off) button on the control panel.**

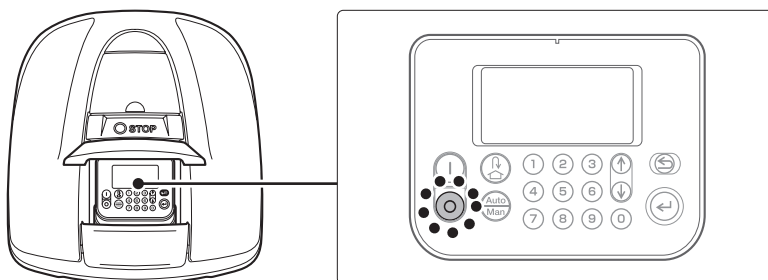

### NOTE:

- When you turn off the lawnmower, it will not begin to operate even if you set the timer.

## ■ Operating the lawnmower in Auto mode

### ● Entering your PIN (Personal Identification Number)

When turning the lawnmower on, you must enter the PIN.

- 1 **Enter the PIN using the number buttons.**

#### NOTE:

- To change the PIN, see “4 MENU SETTINGS” (☞ page 25).

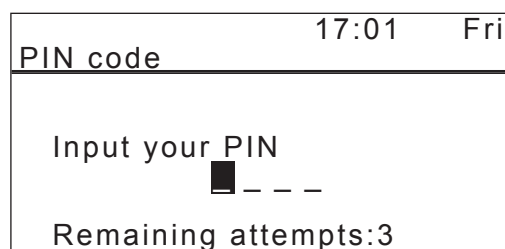

- 2 **Press the ⏻ button.**  
The home screen is displayed.

#### NOTE:

- If you input an incorrect PIN 3 times in a row, the control panel is locked for 5 minutes, during which time you cannot perform operations.
- If you forget the PIN, consult your dealer.
- If an error message is displayed, see “6 TROUBLESHOOTING” (☞ page 60).

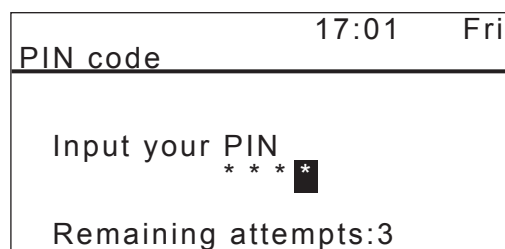

## ● Auto mode operation

These instructions can be used to operate the lawnmower at the time scheduled for the Auto mode settings.

**NOTE:**

- For details on settings, see “4 MENU SETTINGS” (☞ page 25).

**⚠ WARNING**

- Make sure to press the manual STOP button before performing the following procedure.

**1** Press the  button.

**2** If the [Auto] is displayed on the Home screen, go to step 2.  
If the [Man] is displayed on the Home screen, press the  button until the [Auto] is displayed.

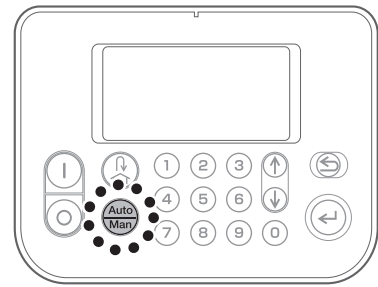

For details on the icons in the screen, see “Home screen” (☞ page 11).

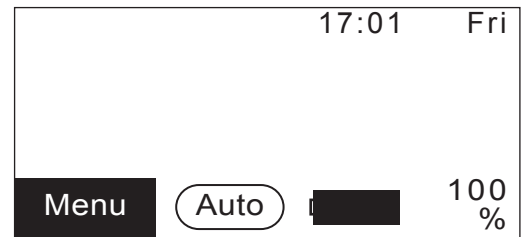

**3** Close the control panel cover.

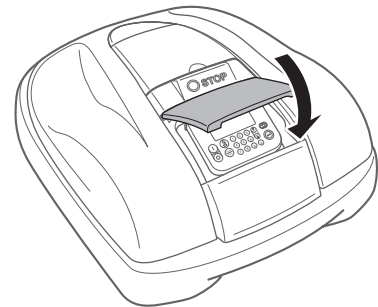

Setting is now complete. The lawnmower starts mowing at the time scheduled for the Auto mode. For details on settings, see “4 MENU SETTINGS” (☞ page 25).

**NOTE:**

- If you press the  (Off) button after configuring these settings, the lawnmower will not activate.

## Adjusting the height of the blades

The height of the blades determines how tall or short the grass will be cut. Test the lawnmower on a small area and adjust blade height according to your preference.

### ⚠ WARNING

- Make sure to press the manual STOP button before performing the following procedure.

### CAUTION:

- Avoid cutting too much at once. Mow gradually step by step (from level 5 to 1.)
- Avoid cutting more than 5 mm of grass at once. If you want to cut more than 5 mm, it should be done gradually in steps of 5 mm maximum per week. Example: decreasing from 50 to 30 mm should require 4 weeks with 5 mm steps.

1

Press the manual STOP button.  
The control panel cover pops up.

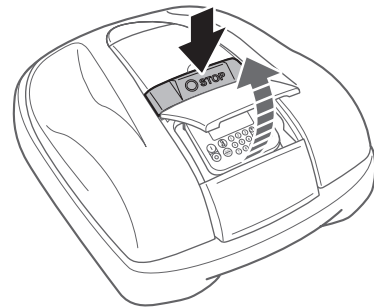

2

Open the height adjustment dial cover with your finger.

Insert your finger here  
and pull up.

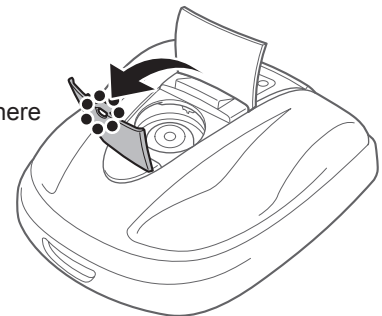

3

Turn the dial anticlockwise to lower the blades, or turn the dial clockwise to raise the blades. Use the numbers on the dial to approximate the height of the blades.

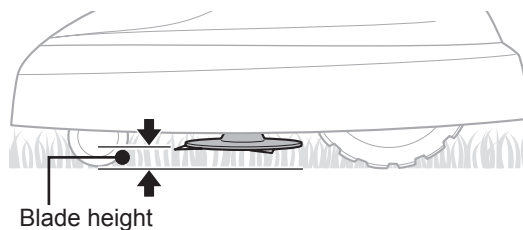

Blade height

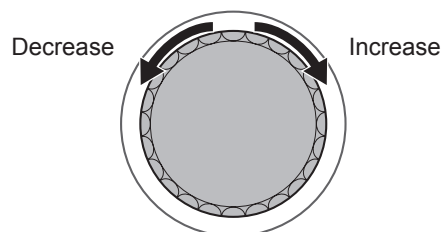

Decrease

Increase

Approximate blade heights for each dial position:

| Position | Approximate blade height |
|----------|--------------------------|
| 1        | 20 mm                    |
| 2        | 30 mm                    |
| 3        | 40 mm                    |
| 4        | 50 mm                    |
| 5        | 60 mm                    |

4

**Close the height adjustment dial cover, and close the control panel cover.**

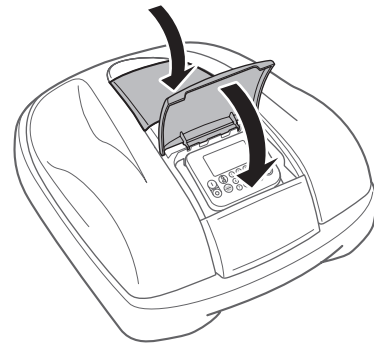

Repeat the steps above if you need to make additional adjustments.

## Weekly checks

Check the lawnmower and docking station once a week to remove dirt and grass. Also check if the blades and blade disc have been damaged, and verify that there are no other problems.

### ● Cleaning the lawnmower and docking station

Dirt and grass may accumulate on the top and bottom of the lawnmower, docking station, and charging plug during and after mowing.

For details on how to clean the lawnmower, see “7 MAINTENANCE” (☞ page 63).

### ● Checking the blades and blade disc for problems

The blades and blade disc may become damaged while mowing. Make sure to perform weekly checks of the blades and blade disc.

For details on how to check the blades and blade disc, see “7 MAINTENANCE” (☞ page 63).



## Carrying the lawnmower

When carrying the lawnmower, observe the following points.

### ⚠ WARNING

- Do not carry the lawnmower with the blades pointed toward you.
- Take care to avoid dropping the lawnmower when carrying it.
- Make sure to press the manual STOP button and turn the lawnmower off before performing the following procedure.
- Make sure the lawnmower (especially the blades) does not touch anyone when you are carrying it.

1. Press the manual STOP button to open the control panel cover, and press the Ⓞ (Off) button.
2. Close the control panel cover.
3. Pick up the lawnmower by the carrying area.

Lift the lawnmower with one hand from the rear side with the blades pointed away from you.

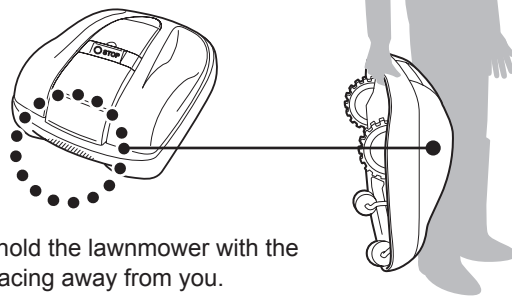

Always hold the lawnmower with the blades facing away from you.

### CAUTION:

- When carrying the lawnmower, make sure to carry it by carrying area at the lower rear of the lawnmower. If carrying it by any other area, you may be injured by the blades or charging socket area of the lawnmower, or the lawnmower may fall and become damaged.
- Do not lift or carry the lawnmower by holding it from the opening in the front.

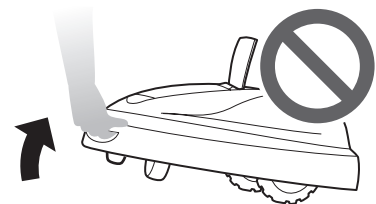

- Do not carry the lawnmower while it is attached to the docking station. The lawnmower and docking station may be damaged.



## 6 TROUBLESHOOTING

### Before contacting your dealer

In the unlikely event that you are facing a problem and you need to contact your dealer, ensure that you have the following information available.

- Owner's Manual
- Consider any recent work in your garden.
- [Fault history] information

 Home screen → [4.History] → [2.Fault history]

### Messages

If any of the following messages appear in the display, use this troubleshooting guide to address the problem before contacting your dealer. If the problem persists, contact your dealer.

| Message  | Cause   | Solution   |
|--|---|--|
| <b>Key pad</b>   | A button was pressed while the lawnmower was running (with the control panel cover closed).         | Open the control panel cover and check if any foreign objects are stuck inside.<br>If this message appears after removing any foreign objects, contact your dealer.                      |
| <b>ENT Key</b>   | The Enter button was pressed while the lawnmower was running (with the control panel cover closed). |  |
| <b>Clock Reset</b>   | The backup battery power has drained during long-term storage. The clock has been reset.            | Set the current date and time. The time must be in 24-hour format.<br>If the clock cannot be set, contact your dealer.   |
| <b>Battery voltage high</b>                                | The battery charges too much.   | Remove the lawnmower from the docking station, set the power to ON, and wait until the message disappears.<br>If the message does not disappear, contact your dealer.                    |
| <b>Battery voltage low</b>                                 | The battery does not charge enough.   | Charge the lawnmower with the docking station. This message disappears if the battery is charged more than 10%.<br>If the message does not disappear, contact your dealer.               |
| <b>Battery temp high</b>                                   | The battery temperature is too high.  | Set the power to ON, and wait until the message disappears.<br>If the message does not disappear, contact your dealer.   |
| <b>Battery temp low (1)</b><br><b>Battery temp low (2)</b> | The battery temperature is too low.   | Put the lawnmower in a place where the temperature 5°C or higher, set the power to ON, and wait until the message disappears.<br>If the message does not disappear, contact your dealer. |

| Message   | Cause  | Solution   |
|---|--|--|
| <b>Outside loop</b>   | The lawnmower exited the boundary wire.  | Move the lawnmower into the work area.<br>Check the power supply of the docking station.<br>Check if the boundary wire connectors are correctly connected.<br>If the message does not disappear, check if the boundary wire connectors are correctly connected, and check if there are no similar lawnmowers in the area.<br>If the message still does not disappear, contact your dealer. |
| <b>Blade motor temp high</b>  | The temperature of the blade motor is or exceeds 85°C.                         | Leave the power ON and the control panel cover open, and wait 15 to 30 minutes until the message disappears. If the message does not disappear, contact your dealer.   |
| <b>Obstruction detection</b>  | An obstruction is being detected, or the sensor detects something.             | Enter the PIN so that the message disappears. If the message does not disappear, contact your dealer.  |
| <b>Obstruction sensor</b>   | Obstruction sensor is inactive, or there is an object interrupting the sensor. | Fully move the main cover in order to check sensors can be activated.<br>Shake : Not possible to recover<br>Turn off : Not possible to recover<br>If "Obstruction sensor" message remains, check around and underneath the cover for any objects like chips, dust or small toys, then remove it, or contact your dealer.   |
| <b>Excessive tilt</b>   | The lawnmower is in an excessively tilted area.                                | Place the lawnmower on a flat surface, and enter the PIN so that the message disappears. If the message does not disappear, contact your dealer.   |
| <b>Mower lifted</b>   | The cover has been lifted by something, e.g. a stone.                          | Enter the PIN so that the message disappears. If the cover is heavily damaged or the message does not disappear, contact your dealer.  |
| <b>Upside down</b>  | The lawnmower is upside down.  | Place the lawnmower on a flat surface, and enter the PIN so that the message disappears. If the message does not disappear, contact your dealer.   |
| <b>Battery capacity reduced</b>                                     | The battery does not charge enough.  | Increase the remaining capacity of homing. See "Homing setup" (☞ page 41). If the message does not disappear, contact your dealer.   |
| <b>Battery capacity low</b>   | The battery does not charge enough.  |  |
| <b>No boundary signal</b>   | The lawnmower does not detect the boundary wire signal.                        | Check a power supply of docking station. See "Test start points" (☞ page 44). If the message does not disappear, contact your dealer.  |
| <b>Area signal lost</b>   | The lawnmower does not detect the boundary wire signal.                        | Check if the boundary wire connectors are correctly connected. If the message does not disappear, contact your dealer.   |
| <b>Contact your dealer if the following messages have appeared.</b> |  |  |
| <b>Area sensor</b>  | <b>Communication Error</b>   | <b>Motor sensor R</b>  |
| <b>Battery Error</b>  | <b>Data memory Error</b>   | <b>Rollover sensor</b>   |
| <b>Battery temperature</b>  | <b>Display Unit Error</b>  | <b>Tilt sensor</b>   |
| <b>Blade motor</b>  | <b>Lift sensor</b>   | <b>Wheel motor</b>   |
| <b>Blade motor blocked</b>  | <b>Manual stop</b>   | <b>Wheel motor blocked</b>   |
| <b>Blade motor relay</b>  | <b>Motor ECU Error</b>   | <b>Wheel motor relay</b>   |
| <b>Charging control</b>   | <b>Motor sensor Blade</b>  | <b>Yaw sensor</b>  |
| <b>Clock</b>  | <b>Motor sensor L</b>  |  |

It may be necessary to exchange the battery. Contact your dealer with the operating history ready (cutting time, charging time, returning time).

## Resolving problems

Unless having the power on is necessary to check something, turn off the power when checking the condition of the lawnmower or the blade.

| Problem   | Solution  |
|---|---|
| The lawnmower cannot be charged.  | Check the connections, and charge the lawnmower again.<br>If the lawnmower cannot be charged, contact your dealer.  |
| The lawnmower will not enter an area, or the blades and movement have stopped.                  | The lawnmower will try to evade an area with a slope of more than 20°. In the case of a 25 - 35deg slope (depending on unevenness of the ground)<br>- The lawnmower will try to escape from the slope<br>In the case of a slope more than 35deg slope<br>- The lawnmower will stop due to "Excessive tilt"  |
| The lawnmower stops frequently.   | Operation of this product with other wireless devices, remote controls, or electric fences is not guaranteed. Contact your dealer.  |
| The lawnmower leaves the preset area or behaves differently from the settings.                  | See the error message on the screen and follow the instructions before contacting your dealer. If you cannot solve the issue, contact your dealer with the error messages ready.  |
| The boundary wire has slackened and come out of the ground or a peg has come out of the ground. | Stop the lawnmower because it may cut the wire.<br>Be careful not to trip on the boundary wire or peg. Contact your dealer.   |
| A strange noise is heard from the lawnmower or the lawnmower vibrates.                          | Check the blades if they are broken or not. Broken blades can create an unbalanced blade disk. It can create noise.<br>Try to use "Quiet timer".<br>Contact your dealer if it cannot be solved.   |
| Lawnmower does not leave the docking station. No error message is displayed.                    | <ul style="list-style-type: none"> <li>- Timers were not set up correctly. Check the timer settings. See "4 MENU SETTINGS" (☰ page 25).</li> <li>- The Date and Time are incorrect. Check the clock (☰ page 50).</li> <li>- The manual STOP button was pressed, but the ⏻ button was not pressed before closing the control panel cover.</li> <li>- The lawnmower is in inactive mode.<br/>Another cause could be that the machine is in "Home" mode.</li> <li>- The lawnmower in the Auto mode will always charge the battery up to 100%.<br/>If you want to make the lawnmower to start mowing sooner, change the operating mode to the Manual mode.</li> </ul>                                 |
| Poor mowing results.  | <ul style="list-style-type: none"> <li>- The cutting height is incorrect or the grass is too high. Adjust the cutting height or cut with a standard lawnmower first if the grass is too high.</li> <li>- Check the condition of the blades (☰ page 68).</li> </ul>  |
| Lawnmower does not work inside the boundary wire.   | <ul style="list-style-type: none"> <li>- If there are electromagnetic and electric fields near the boundary wire such as power line, factory, electric noise might affect the movement of your lawnmower. Contact your dealer.</li> <li>- A power failure occurred. The lawnmower behaves as follows:<br/>In case that the power supply is cut off for more than 30 minutes, the lawnmower will shut off automatically to prevent the battery from becoming empty.<br/>In case that the power supply comes back within 30 minutes, the lawnmower will start mowing automatically. *</li> </ul> <p>* The lawnmower will return to the docking station if the battery residual capacity is low.</p> |
| The lawnmower goes out of the boundary wire.  | Record where the lawnmower goes out of wire.<br>Check the ground condition, weather condition and tyre condition when the lawnmower goes out of the boundary wire. Clean up the tyre if it has any mud, leaves, or grass. Try to continue. If the issue occurs frequently, contact your dealer.   |
| The lawnmower does not dock into the docking station.   | Check station condition if it deformed or not. Check boundary wire underneath the station (☰ page 12). Clean up the charging terminal of both the lawnmower and station.  |
| Noticeable wheel tracks.  | Try to reduce the work timer.<br>You can reduce the work timer automatically by using "Seasonal timer". Try to increase "passage width".  |
| The lawnmower does not enter narrow corridors.  | Check the "passage width" setting. If necessary, you can use the "Narrow passage" function (☰ page 37).   |

# 7 MAINTENANCE

## Periodic inspection and maintenance

The lawnmower must be periodically inspected and maintained for safety and to keep it running at a high level of performance.

Periodic maintenance will also help to extend service life.

The required service intervals and the kind of maintenance to be performed are described in the following chart. Honda recommends annual service to be completed by your local authorised Honda dealer. The dealer will be able to perform a variety of checks and software updates that cannot be completed by the owner.

### Maintenance schedule

| REGULAR SERVICE PERIOD   |                    | Every week | Every year or every 840h operating hours. (Cutting time) | Page        |
|--|--------------------|------------|--|-------------|
| Perform at every indicated period or operating hour interval, whichever comes soonest. |                    |            |  |             |
| Blade & Blade nut *1   | Check              | ○          |  | (☞ page 68) |
| Blade disk *1  | Check              | ○          |  | (☞ page 68) |
| Drain hole   | Check or clean     | ○          | ○ *2   | –           |
| Manual stop button   | Check              |            | ○  | (☞ page 65) |
| Body parts *1  | Clean              | ○          |  | (☞ page 64) |
|  | Check              |            | ○ *2   | –           |
| Docking station  | Clean              | ○          |  | (☞ page 65) |
|  | Check              |            | ○  | (☞ page 66) |
| Docking station Screws   | Check or tightness | ○ *3       |  | (☞ page 67) |
| Rear (drive) wheels *1   | Clean              | ○          |  | (☞ page 64) |
|  | Check              |            | ○ *2   | –           |
| Rear wheels axle   | Grease             |            | ○ *2   | –           |
| Front (caster) wheels *1   | Clean              | ○          |  | (☞ page 64) |
|  | Check              |            | ○ *2   | –           |
| Front caster ball bearing & bush   | Check              |            | ○ *2   | –           |
|  | Replace            |            | if necessary *2  | –           |
| Frame inside   | Clean              |            | ○ *2   | –           |
| Frame seals  | Replace            |            | ○ *2   | –           |
| Obstruction sensors (case, springs and lift washer)                                    | Check or clean     |            | ○ *2   | –           |
|  | Replace            |            | ○ *2   | –           |
| Docking station (boundary wire connectors)   | Check              |            | if necessary *2  | –           |
|  | Clean              |            | ○ *2   | –           |
| Docking station (charging plug)  | Check              |            | ○ *2   | –           |
| Mower recharging plates  | Clean              |            | ○ *2   | –           |
|  | Replace            |            | if necessary *2  | –           |
| Battery condition  | Check              |            | ○ *2, *4   | –           |

\*1 Blades, the blade nuts, the blade disk, body parts, the front (caster) wheels, and the rear (drive) wheels should be replaced as needed.

\*2 These items should be serviced by your servicing dealer, unless you have the proper tools and are mechanically proficient. Refer to Honda shop manual for service procedures.

\*3 If the screws become loose, tighten them securely.

\*4 Confirm using 10 last charges history.

## Maintenance procedures

Dirt and grass may accumulate on the top and bottom of the lawnmower during and after mowing, and the blades may become worn, damaged, or unable to turn. Make sure to check the lawnmower according to the chart in “Periodic inspection and maintenance” (☞ page 63).

### ▲ WARNING

- Make sure to press the manual STOP button and turn the lawnmower off before performing the following procedures.
- Put on a pair of work gloves before performing the following procedures.
- Be careful when performing the following procedures, because blades are extremely sharp.

### NOTE:

- Remove the lawnmower from the docking station when performing the following procedures.

## ■ Preparing

Perform the following procedures in an area not subject to rainfall.

- Put on a pair of work gloves.
- When checking the blades, turn the lawnmower on its side.
- Do not tilt the lawnmower over an angle of 90 degrees to prevent grass clippings or fluid from entering inside the lawnmower.

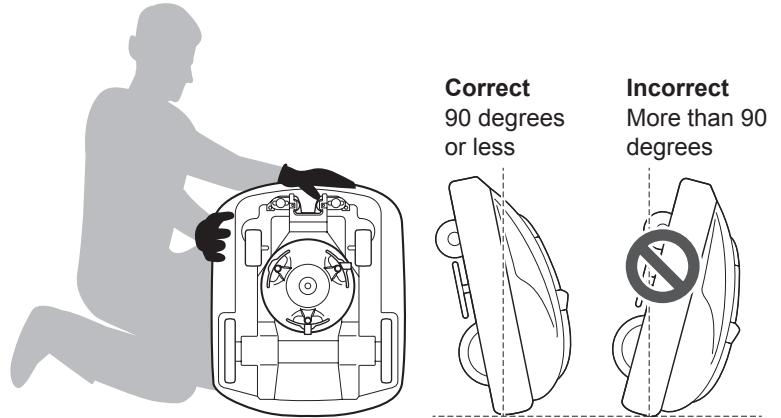

## ■ Cleaning

### ▲ WARNING

- Do not touch the blades with your hands.
- Do not lift the lawnmower off of the ground while checking or cleaning it.
- Make sure to press the manual STOP button and turn the lawnmower off before performing the following procedures.

### NOTE:

- Do not wash the lawnmower with water. The lawnmower may be damaged.



## ● Cleaning the body (Exterior)

Clean dirt and grass off of the lawnmower using a brush and cloth.

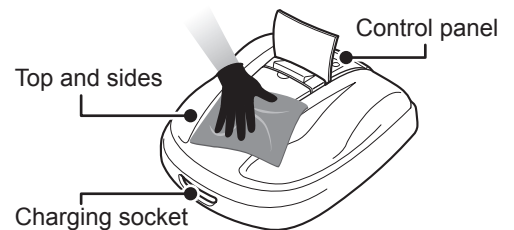

## ● Removing the grass clippings

By using a dried brush or scraper, remove the grass clippings attached to the blades, driving part and water drain holes.

### NOTE:

- Never pour water on the bottom of the lawnmower, and avoid using a sponge or rag soaked with water for cleaning the lawnmower. The lawnmower may be damaged if water or dirt such as grass clippings enter inside of the lawnmower through the drain holes or gaps.

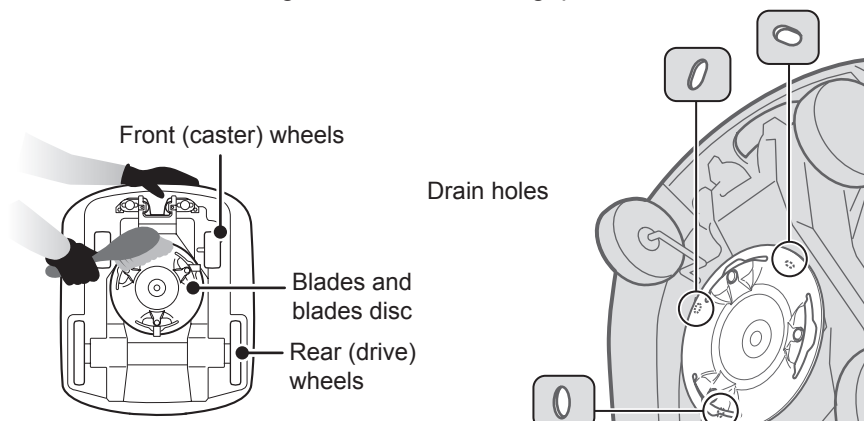



## ● Cleaning the docking station

### ▲ WARNING

- Unplug the transformer's plug from the power outlet (House) before cleaning it.

Clean dirt and grass off of the docking station using a brush.

Brush off dirt and grass from docking station, particularly around parts on which the lawnmower rests and around the charging plug area:

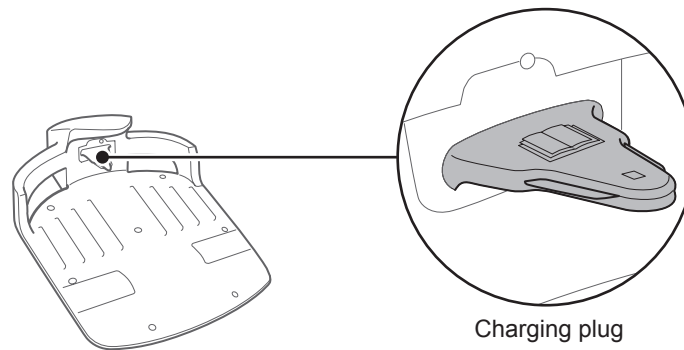

## ■ Checking

### ● Checking the manual STOP button

### ▲ WARNING

- Do not touch the blades with your hands.
- Do not lift the lawnmower off of the ground while checking or cleaning it.

| Check item(s)                              |  | Action   |
|--|--|--|
| Manual STOP button and control panel cover | Normal operation of the manual STOP button (and the control panel cover) | While performing a test operation of the lawnmower, press the manual STOP button. If the lawnmower does not stop (and the control panel cover does not open), consult your dealer. |

- 1 Press the ⓪ (On) button on the control panel.
- 2 Test a start point (▣ page 44). When the lawnmower is moving, press the manual STOP button and check that the lawnmower stops.

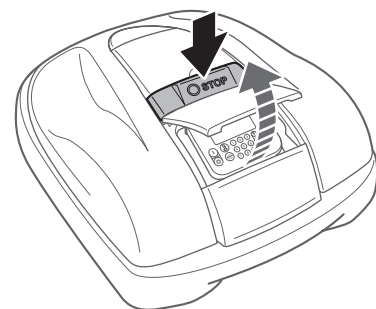

## ● Checking the docking station

Check the docking station for problems.

| Check item(s)   |  | Action   |
|-----------------|--|--|
| Docking station | Damage to the docking station              | Visually inspect the docking station. If it is damaged, consult your dealer. |
| Connectors      | Loosened connectors of the docking station | Visually inspect the connectors. If they are loose, consult your dealer.     |

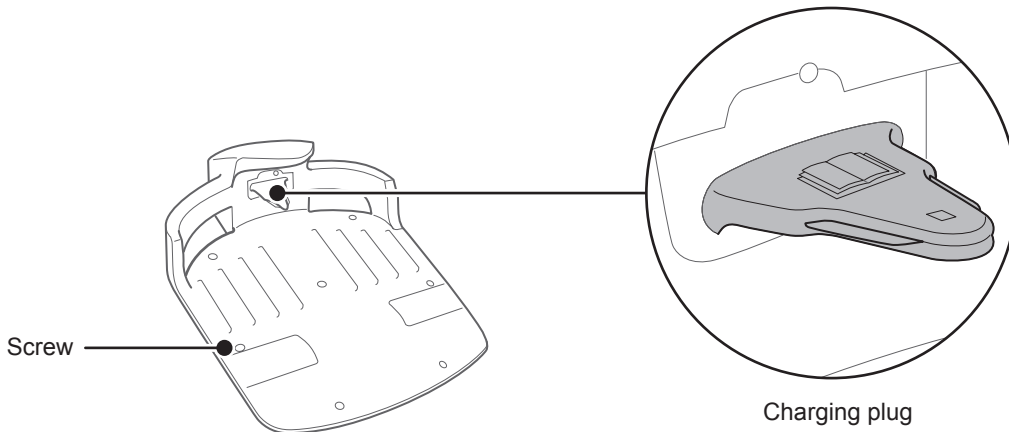

| Check item(s)   |   | Action  |
|-----------------|---|---|
| Docking station | Gap between the docking station's charging plug and the lawnmower's charging socket | Check if there is a gap between the docking station's charging plug and the lawnmower's charging socket. If there is not, adjust the docking station. |

**1** Locate both rear wheels of the lawnmower at the highest position of the docking station.

**2** Check if there is a gap between the docking station's charging plug and the lawnmower's charging socket. If there is not, adjust the docking station.

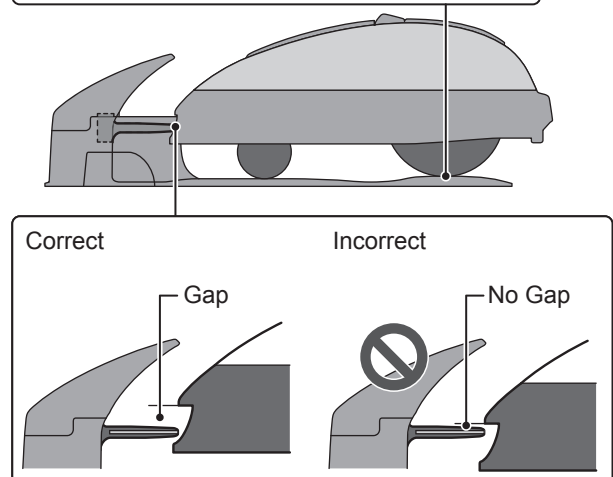
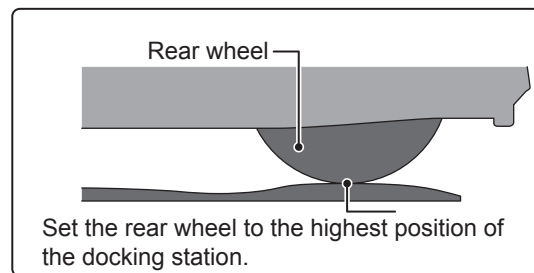



## ● Checking the docking station screws

| Check item(s)   |  | Action   |
|-----------------|--|--|
| Docking station | Loosened screws of the docking station | Visually inspect the screws.<br>If they are loose, tighten them with a flat-blade screwdriver. |

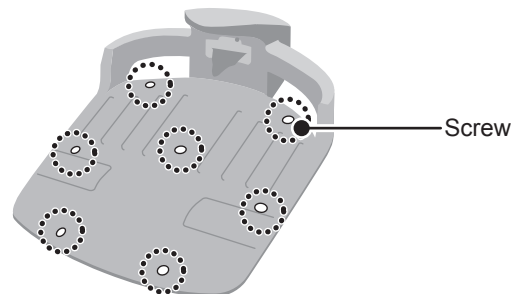

## ● Checking the blades and blade disc

Check the condition of the blades and blade disc as follows.

### Life time of the blades

In order to have good cutting performance, maintain the sharp cutting edge on the blades. Typically, the life time of the blades is 160 hours.(2 weeks to 2 months) Because the life time depends on grass condition, it may be necessary to exchange earlier than usual, especially in the spring season.

If your lawn will become the condition of white fiber it is a sign to change blades.

Example: if the lawnmower works for 11.4 hours per day every day, the life time of the blades is 2 weeks.

If the lawnmower works for 2.6 hours per day every day, the life time of the blades is 2 months.

### ▲ WARNING

- Do not touch the blades with your hands.
- Make sure to press the manual STOP button and turn the lawnmower off before performing the following procedures.

### NOTE:

- Hold the lawnmower against a wall for support.
- Do not lift the lawnmower off of the ground while checking it.

Check the blades, nuts and blade disc for problems.

| Check item(s)   |   | Action  |
|-----------------|---|---|
| Blades and nuts | Damage to the blades  | Visually inspect the blades.<br>If they are damaged, replace the blades. See "Replacing the blades" (☞ page 69).  |
|                 | Loosened bases of the blades  | Rotate the nuts with your finger to check that they are not loose.<br>If the nuts are loose, tighten them to the specified torque value. See "Replacing the blades" (☞ page 69).  |
|                 | Abrasions of the holes of blades and abrasions of the shoulders of nuts | Visually inspect the abrasions of the hole of blades and the abrasions of the shoulder of nuts.<br>While mowing, the hole of the blades will widen and the shoulder of the nuts will decrease in size because of abrasions, and there is a danger that the blades will be detached from the blade disc.<br>If they are worn, replace the blades and nuts. See "Replacing the blades" (☞ page 69). |
| Blade disc      | Warping of the blade disc   | Rotate the blade disc and visually check it.<br>If it is warped, consult your dealer.   |

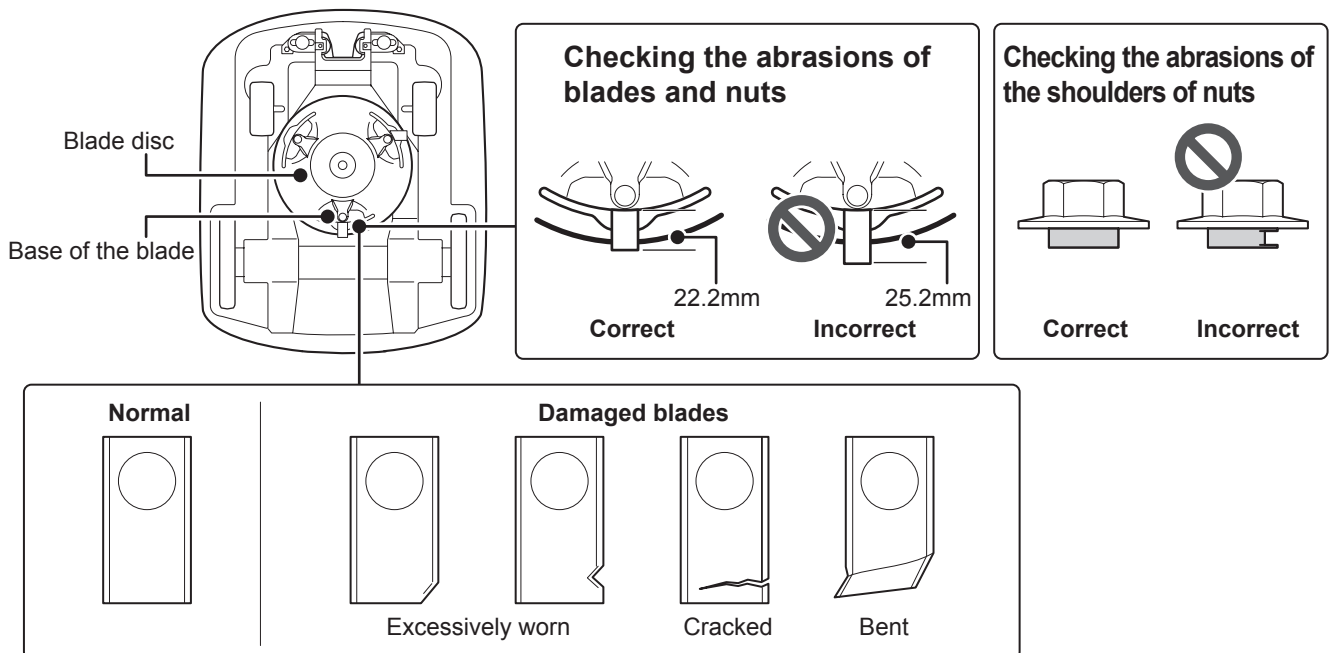

## Replacing the blades

To replace the blades, perform the procedures below.

### ▲ WARNING

- Put on a pair of work gloves before performing the following procedures.
- Do not touch the blade while it is spinning. You may be injured if you do so.

### NOTE:

- This work requires technical skill and knowledge, as well as special tools. Consult your dealer if you cannot perform the procedures below.
- Before replacing the blades, remove the grass clippings (☞ page 64).
- Use genuine parts or their equivalent for the blade.

| Replacement Item(s) | Part number   |
|---------------------|---------------|
| Blade               | 72511-VP7-030 |
| Nut                 | 90305-VP7-000 |

**1** Turn the power off. Adjust the height of the blades to position 1 and turn the lawnmower upside down.

**2** Hold the base of the blade disc with a 24 mm spanner so that the blade disc does not rotate when you rotate the nuts.

**3** Remove the nut from each blade with a 8 mm spanner.

**4** Replace the blades, insert each blade through each bolt on the blade disk, and lightly tighten a nut with the 8 mm spanner.

### NOTE:

- Tighten the nuts after the shoulders of the nut is securely in the hole of the blade.

**5** Tighten the nuts to the specified torque value using a torque wrench.

**4.4~6.0 N • m (0.45~0.60 kgf • m, 3.2~4.4 lbf • ft)**

### NOTE:

- If you do not have a torque wrench, have your dealer perform the work.
- Use a torque wrench between the blade disc and the lawnmower body.

**6** Check that the blades rotate smoothly. If they do not rotate smoothly, remove and install the nuts again.

**Hold the blade disc in place**  
Insert a spanner between the blade disc holder and the lawnmower body.

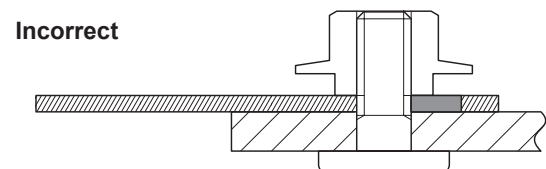
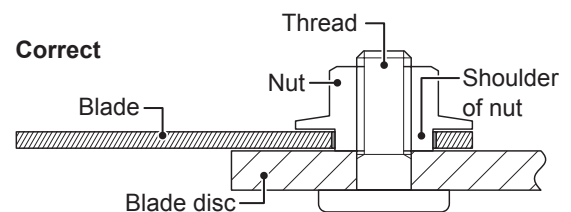
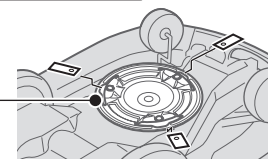

# 8 STORAGE

## ■ Winter Storage

### ■ Lawnmower and Docking station

It is very important that your lawnmower and docking station is cleaned thoroughly before placing into storage. The battery should be charged before it is stored in a dry place away from frost and protected from the winter weather.

|   |          |
|---|----------|
| Recommended battery charge level for long storage | 50 - 70% |
|---|----------|

## ■ Electrical Components

It is strongly recommended that you disconnect the transformer and power cables over winter leaving only the boundary wire in the ground. Spray electrical contact cleaner on boundary wire terminals before encasing them in a waterproof box (e.g. electrical junction box) to ensure they do not corrode over the winter period. Honda recommends that all electrical components such as the transformer should be stored in a dry, frost free environment that is not exposed to the winter weather.

## ■ Get your lawnmower ready for the new season

Once the winter season has passed and it is time to recommence your lawnmower operation it is strongly recommended that you consult your dealer. An authorised dealer will check that all systems are functioning correctly and that your lawnmower is safe to begin mowing for the forthcoming season.

# 9 TECHNICAL INFORMATION

## Specifications

| Model   | HRM310  |                |          |          | HRM520                      |          |          |          |          |
|---|---|----------------|----------|----------|-----------------------------|----------|----------|----------|----------|
| Description code  | MBEF  |                |          |          | MBDF                        |          |          |          |          |
| Type  | EAE   | EAEN           | EAB      | EAS      | EAE                         | EAEN     | EAB      | EAS      |          |
| Length  | 645 mm  |                |          |          |                             |          |          |          |          |
| Width   | 550 mm  |                |          |          |                             |          |          |          |          |
| Height  | 275 mm  |                |          |          |                             |          |          |          |          |
| Weight  | 11.6 kg   |                |          |          | 11.9 kg                     |          |          |          |          |
| <b>Electrical system</b>                                      |   |                |          |          |                             |          |          |          |          |
| Battery   | Li-ion<br>22.2 V / 1800 mAh   |                |          |          | Li-ion<br>22.2 V / 3600 mAh |          |          |          |          |
| Transformer   | Input   | AC 230 V       | AC 230 V | AC 240 V | AC 230 V                    | AC 230 V | AC 230 V | AC 240 V | AC 230 V |
|   | Output  | 26.0 V / 2.3 A |          |          |                             |          |          |          |          |
| <b>Mowing</b>   |   |                |          |          |                             |          |          |          |          |
| Blade motor speed   | 2500 rpm (Normal) / 2200 rpm (Low)  |                |          |          |                             |          |          |          |          |
| Cutting height  | 20-60 mm  |                |          |          |                             |          |          |          |          |
| Cutting width   | 22 cm   |                |          |          |                             |          |          |          |          |
| <b>Boundary wire</b>  |   |                |          |          |                             |          |          |          |          |
| Boundary wire length<br>(Comes with the product)              | 200 m   |                |          |          | 300 m                       |          |          |          |          |
| Maximum possible length<br>(Option parts)                     | 400 m   |                |          |          | 800 m                       |          |          |          |          |
| Frequency band(s)   | 2.5 kHz - 5 kHz   |                |          |          |                             |          |          |          |          |
| Maximum radio-frequency power                                 | < 82 dB $\mu$ A/m @10m  |                |          |          |                             |          |          |          |          |
| <b>Noise</b>  |   |                |          |          |                             |          |          |          |          |
| Sound pressure level at operator's ears<br>EN50636-2-107:2015 | Measured level 47 dB(A)<br>Measuring uncertainty +2.5 dB(A)<br>(Not exceeding 70 dB(A)) |                |          |          |                             |          |          |          |          |

# 10 APPENDIX

## Operating the lawnmower with the Manual mode

This setting can be used when 2 or more areas within the boundary wire are connected by a narrow path. If you have 2 or more areas within the boundary wire connected by a path that is less than 1 meter wide, the lawnmower cannot pass between them, and must be carried to the other area manually. Follow the steps below when performing this procedure.

### Manual mode operation

These instructions can be used to operate the lawnmower for the Manual mode settings.

1

See "Manual Mode" (☞ page 38) to configure settings for Manual Mode.

2

Press the  (Off) button on the control panel.  
The power turns off.

3

Close the control panel cover.

4

Carry the lawnmower to the desired area.  
For details on carrying the lawnmower, see "7 MAINTENANCE" (☞ page 63).

5

Press the manual STOP button.  
The control panel cover pops up.

6

Press the  (On) button on the control panel.  
The power turns on, and the startup screen on the control panel is displayed.

7

Enter the PIN using the number buttons to display the Home screen.

8

Press the  (Auto / Manual) button repeatedly until Manual mode screen is displayed.

|                                     |                                |     |
|-------------------------------------|--------------------------------|-----|
|                                     | 17:01                          | Fri |
| Manual mode                         |                                |     |
| <input checked="" type="checkbox"/> | Mow until empty                |     |
| <input type="checkbox"/>            | Mow then recharge continuously |     |
| <input type="checkbox"/>            | Mow then resume auto timer     |     |

9

Select an operation of lawnmower.

| Items                          | Description  |
|--------------------------------|--|
| Mow until empty                | The lawnmower works until battery is empty.  |
| Mow then recharge continuously | The lawnmower works and charges until the work timer is changed to Auto mode by the user.            |
| Mow then resume auto timer     | The lawnmower works and charges once then switches automatically to Auto mode and resumes the timer. |

- 10 Press the ⏪ button.
- 11 Press the ⏩ button to return to the Home screen.
- 12 **Close the control panel cover.**  
The lawnmower automatically begins to operate.

**NOTE:**

- The lawnmower does not turn off automatically when in manual mode.

## ● Canceling the Manual mode operation

You can cancel the operation which you selected on the Manual mode screen and the lawnmower returns to the docking station.

- 1 **Press the manual STOP button from behind the lawnmower.**  
**NOTE:**  
- If you select [Mow then resume auto timer] the lawnmower will stop at the time of the work timer configured in the Auto mode.
- 2 **Press the ⏻ (Off) button on the control panel.**  
The power turns off.
- 3 **Place the lawnmower in a area that is near the docking station.**
- 4 **Press the ⏻ (On) button on the control panel.**  
The power turns on, and the startup screen on the control panel is displayed.
- 5 **Enter the PIN using the number buttons to display the Home screen.**
- 6 **Press the ⏩ (Home) button.**
- 7 **Select the operation of lawnmower after going back to the docking station.**

|                                     |                       |
|-------------------------------------|-----------------------|
| 17:01                               | Fri                   |
| Go back home                        |                       |
| Then after charging:                |                       |
| <input type="checkbox"/>            | Restart on next timer |
| <input checked="" type="checkbox"/> | Stay at home          |

| Items                 | Description   |
|-----------------------|---|
| Restart on next timer | The lawnmower goes back home, then switches automatically to Auto mode and resumes the timer. |
| Stay at home          | The lawnmower stays at the docking station after charging.                                    |

8

**Press the  button.**

The power turns on, and the startup screen on the control panel is displayed.

9

**Press the  button to return to the Home screen.**

10

**Close the control panel cover.**

The lawnmower returns to the docking station.



# Major Honda Distributor Addresses

**AUSTRIA**  
**Honda Motor Europe Ltd**  
 Hondastraße 1  
 2351 Wiener Neudorf  
 Tel.: +43 (0)2236 690 0  
 Fax: +43 (0)2236 690 480  
 http://www.honda.at  
 ☒ HondaPP@honda.co.at

**BALTIC STATES**  
 (Estonia/Latvia/ Lithuania)  
**NCG Import Baltics OU**  
 Meistri 12  
 Haabersti District  
 13517 Tallinn  
 Harju County Estonia  
 Tel.: +372 651 7300  
 Fax: +372 651 7301  
 ☒ info.baltic@ncgimport.com

**BELGIUM**  
**Honda Motor Europe Ltd**  
 Doornveld 180-184  
 1731 Zellik  
 Tel.: +32 2620 10 00  
 Fax: +32 2620 10 01  
 http://www.honda.be  
 ☒ BH\_PE@HONDA-EU.COM

**BULGARIA**  
**Premium Motor Ltd**  
 Andrey Lyapchev Blvd no 34  
 1797 Sofia  
 Bulgaria  
 Tel.: +3592 423 5879  
 Fax: +3592 423 5879  
 http://www.hondamotor.bg  
 ☒ office@hondamotor.bg

**CROATIA**  
**Hongoldonia d.o.o.**  
 Vukovarska ulica 432a  
 31000 Osijek, HR  
 Tel.: +38531320420  
 Fax: +38531320429  
 http://www.hongoldonia.hr  
 ☒ prodaja@hongoldonia.hr

**CYPRUS**  
**Demstar Automotive Ltd**  
 Mihail Giorgalla 14  
 2409 Engomi  
 Nicosia  
 Cyprus  
 Tel.: +357 22 792 600  
 Fax: +357 22 430 313

**CZECH REPUBLIC**  
**BG Technik cs., a.s.**  
 U Zavodiste 251/8  
 15900 Prague 5 - Velka  
 Chuchle  
 Tel.: +420 2 838 70 850  
 Fax: +420 2 667 111 45  
 http://www.honda-stroje.cz

**DENMARK**  
**TIMA A/S**  
 Ryttermarken 10  
 DK-3520 Farum  
 Tel.: +45 36 34 25 50  
 Fax: +45 36 77 16 30  
 http://www.tima.dk

**FINLAND**  
**OY Brandt AB.**  
 Tuupakantie 7B  
 01740 Vantaa  
 Tel.: +358 207757200  
 Fax: +358 9 878 5276  
 http://www.brandt.fi

**FRANCE**  
**Honda Motor Europe Ltd**  
 Division Produit d'Equipement  
 Parc d'activités de Pariest,  
 Allée du 1er mai  
 Croissy Beaubourg BP46, 77312  
 Marne La Vallée Cedex 2  
 Tel.: 01 60 37 30 00  
 Fax: 01 60 37 30 86  
 http://www.honda.fr  
 ☒ espace-client@honda-eu.com

**GERMANY**  
**Honda Deutschland**  
**Niederlassung der Honda Motor**  
**Europe Ltd.**  
 Hanauer Landstraße 222-224  
 D-60314 Frankfurt  
 Tel.: 01805 20 20 90  
 Fax: +49 (0)69 83 20 20  
 http://www.honda.de  
 ☒ info@post.honda.de

**GREECE**  
**Saracakis Brothers S.A.**  
 71 Leoforos Athinon  
 10173 Athens  
 Tel.: +30 210 3497809  
 Fax: +30 210 3467329  
 http://www.honda.gr  
 ☒ info@saracakis.gr

**HUNGARY**  
**Motor Pedo Co., Ltd.**  
 Kamaraderi ut 3.  
 2040 Budaors  
 Tel.: +36 23 444 971  
 Fax: +36 23 444 972  
 http://www.hondakisgepek.hu  
 ☒ info@hondakisgepek.hu

**IRELAND**  
**Two Wheels Ltd**  
 M50 Business Park, Ballymount  
 Dublin 12  
 Tel.: +353 1 4381900  
 Fax: +353 1 4607851  
 http://www.hondaireland.ie  
 ☒ sales@hondaireland.ie

**ITALY**  
**Honda Motore Europe Ltd**  
 Via della Cecchignola, 13  
 00143 Roma  
 Tel.: +848 846 632  
 Fax: +39 065 4928 400  
 http://www.hondaitalia.com  
 ☒ info.power@honda-eu.com

**MALTA**  
**The Associated Motors**  
**Company Ltd.**  
 New Street in San Gwakklin Road  
 Mriehel Bypass, Mriehel QRM17  
 Tel.: +356 21 498 561  
 Fax: +356 21 480 150  
 ☒ mgalea@gasanzammit.com

**NORWAY**  
**Berema AS**  
 P.O. Box 454 1401 Ski  
 Tel.: +47 64 86 05 00  
 Fax: +47 64 86 05 49  
 http://www.berema.no  
 ☒ berema@berema.no

**POLAND**  
**Aries Power Equipment**  
 Puławska 467  
 02-844 Warszawa  
 Tel.: +48 (22) 861 43 01  
 Fax: +48 (22) 861 43 02  
 http://www.ariespower.pl  
 http://www.mojahonda.pl  
 ☒ info@ariespower.pl

**PORTUGAL**  
**GROW Produtos de Forca**  
**Portugal**  
 Rua Fontes Pereira de Melo, 16  
 Abrunheira, 2714-506 Sintra  
 Tel.: +351 211 303 000  
 Fax: +351 211 303 003  
 http://www.grow.com.pt  
 ☒ geral@grow.com.pt

**REPUBLIC OF BELARUS**  
**Scanlink Ltd.**  
 Montazhnikov Lane 4th 5-16  
 Minsk 220019  
 Republic of Belarus  
 Tel.: +375 17 234 99 99  
 Fax: +375 17 234 04 04  
 http://www.hondapower.by

**ROMANIA**  
**Hit Power Motor Srl**  
 7-15 Argonomici Boluevard  
 Building N3.2  
 Entrance A  
 Apt 8, Floor 2  
 Sector 1  
 015141 Bucharest  
 Tel.: +40 21 637 04 58  
 Fax: +40 21 637 04 78  
 http://www.honda.ro/  
 http://honda-eu.ro  
 ☒ office@honda.ro

**SERBIA & MONTENEGRO**  
**ITH Trading Co Doo**  
 Majke Jevrosime 26  
 1100 Beograd  
 Serbia  
 Tel.: +381 11 3240627  
 Fax: +381 11 3240627  
 http://www.hondasrbija.co.rs  
 ☒ sstevanovic@ithtrading.co.rs

**SLOVAK REPUBLIC**  
**Honda Motor Europe Ltd**  
**Slovensko, organizačná zložka**  
 Prievozská 6 821 09 Bratislava  
 Tel.: +421 2 32131111  
 Fax: +421 2 32131112  
 http://www.honda.sk

**SLOVENIA**  
**AS Domzale Moto Center D.O.O.**  
 Biatnica 3A  
 1236 Trzin  
 Tel.: +386 1 562 3700  
 Fax: +386 1 562 3705  
 http://www.honda-as.com  
 ☒ informacije@honda-as.com

**SPAIN & all provinces**  
**Greens Power Products, S.L.**  
 Poligono Industrial Congost –  
 Av Ramon Ciarans n°2  
 08530 La Garriga - Barcelona  
 Tel.: +34 93 860 50 25  
 Fax: +34 93 871 81 80  
 http://www.hondaencasa.com

**SWEDEN**  
**Honda Motor Europe Ltd filial**  
**Sverige**  
 Box 31002 - Långhusgatan 4  
 215 86 Malmö  
 Tel.: +46 (0)40 600 23 00  
 Fax: +46 (0)40 600 23 19  
 http://www.honda.se  
 ☒ hpesinfo@honda-eu.com

**SWITZERLAND**  
**Honda Motor Europe Ltd., Slough**  
**Succursale de Satigny/Genève**  
 Rue de la Bergère 5  
 1242 Satigny  
 Tel.: +41 (0)22 989 05 00  
 Fax: +41 (0)22 989 06 60  
 http://www.honda.ch

**TURKEY**  
**Anadolu Motor Uretim Ve**  
**Pazarlama As**  
 Sekerpinar Mah  
 Albayrak Sok No 4  
 Cayirova 41420  
 Kocaeli  
 Tel.: +90 262 999 23 00  
 Fax: +90 262 658 94 17  
 http://www.anadolumotor.com.tr  
 ☒ antor@antor.com.tr

**UNITED KINGDOM**  
**Honda Motor Europe Ltd**  
 Cain Road  
 Bracknell  
 Berkshire  
 RG12 1 HL  
 Tel.: +44 (0)845 200 8000  
 http://www.honda.co.uk

# "EC Declaration of Conformity" CONTENT OUTLINE

## EC Declaration of Conformity

- The undersigned, \*2, representing the manufacturer, herewith declares that the machinery described below fulfils all the relevant provisions of:
  - Directive 2006/42/EC on machinery
  - Directive 2014/30/EU on electromagnetic compatibility
  - Directive 2014/35/EU relating to electrical equipment designed for use within certain voltage limits
  - Directive 2014/53/EU on radio equipment
  - Directive 2011/65/EU on the restriction of the use of certain hazardous substances in electrical and electronic equipment

2. Description of the machinery

- Product: Robotic lawnmower
- Function: Cutting of grass

| c) Model | d) Type | e) Serial number |
|----------|---------|------------------|
| *1       | *1      |                  |

- Manufacturer and able to compile the technical documentation  
Honda France Manufacturing S.A.S.  
Pôle 45 - Rue des Châtaigniers 45140 ORMES - FRANCE

4. References to applied standards

|                                  |  |
|----------------------------------|--|
| EN 60335-1:2012/A11:2014/AC:2014 | EN 301 489-1 V1.9.2                      |
| EN 50636-2-107:2015              | Draft ETSI EN 301 489-1 V2.2.0 (2017-03) |
| EN 55014-1:2006/A1:2009/A2:2011  | ETSI EN 303 447 V1.1.1 (2017-09)         |
| EN 55014-2:2015                  |  |
| EN 61000-3-2:2014                |  |
| EN 61000-3-3: 2013               |  |

5. 2014/53/EU: Annex III (Module B, EU-type examination)

The notified body (VDE, 0366) performed EU-type examination and issued the EU-type examination certificate: \*2

- Done at: ORMES , FRANCE
- Date: \*2

\*2  
President  
Honda France Manufacturing S.A.S.

\*1 : See specification page  
\*2 : See original EC Declaration of Conformity

| Fransais (French)  | Italiano (Italian)  | Deutsch (German)   | Nederlands (Dutch)  |
|--|---|--|---|
| <p><b>Fransais (French)</b><br/>Déclaration CE de Conformité<br/>1. Le soussigné, *2, représentant du constructeur, déclare que la machine décrit ci-dessous répond à toutes les dispositions applicables de<br/>* Directive Machine 2006/42/CE<br/>* Directive 2014/30/UE en lien avec la compatibilité électromagnétique<br/>* Directive 2014/35/UE relatives au matériel électrique destiné à être employé dans certaines limites de tension<br/>* Directive 2014/53/UE concernant les équipements hertziens<br/>* Directive 2011/65/UE relative à la limitation de l'utilisation de certaines substances dangereuses dans les équipements électriques et électroniques<br/>2. Description de la machine<br/>a) Produit: Tondeuse à gazon robotisée<br/>b) Fonction : couper de l'herbe (tondre)<br/>c) Modèle d) Type e) Numéro de série<br/>3. Constructeur et en charge des éditions de documentation techniques<br/>4. Référence aux normes appliquées<br/>5. 2014/53/UE : ANNEXE III (Module B, Examen UE de type)<br/>l'organisme notifié (VDE, 0366) a réalisé Examen UE de type et a délivré le certificat d'examen UE de type:<br/>6. Fait à<br/>7. Date</p> | <p><b>Italiano (Italian)</b><br/>Dichiarazione CE di Conformità<br/>1. Il sottoscritto, *2 in rappresentanza del costruttore, dichiara qui di seguito che la macchina sotto descritta soddisfa tutte le disposizioni pertinenti delle:<br/>* Direttiva macchina 2006/42/CE<br/>* Direttiva 2014/30/UE sulla compatibilità elettromagnetica<br/>* Direttiva 2014/35/UE relativa al materiale elettrico destinato ad essere adoperato entro taluni limiti di tensione<br/>* Direttiva 2014/53/UE riguardante le apparecchiature radio<br/>* Direttiva 2011/65/UE sulla restrizione dell'uso di determinate sostanze pericolose nelle apparecchiature elettriche ed elettroniche<br/>2. Descrizione della macchina<br/>a) Prodotto: Rasaerba robotizzato<br/>b) Funzione : Taglio di erba<br/>c) Modello d) Tipo e) Numero di serie<br/>3. Costruttore e competente per la compilazione della documentazione tecnica<br/>4. Riferimento alle norme applicate<br/>5. 2014/53/UE: ALLEGATO III (Modulo B, Esame UE del tipo)<br/>l'organismo notificato (VDE, 0366) ha effettuato Esame UE del tipo e rilasciato il certificato di esame UE del tipo:<br/>6. Fatto a<br/>7. Data</p> | <p><b>Deutsch (German)</b><br/>EG-Konformitätserklärung<br/>1. Der Unterzeichner, *2 der den Hersteller vertritt, erklärt hiermit dass das hierunter genannte Maschine allen einschlägigen Bestimmungen der * entspricht.<br/>* Maschinenrichtlinie 2006/42/EG<br/>* Richtlinie 2014/30/UE über die elektromagnetische Verträglichkeit<br/>* Richtlinie 2014/35/UE betreffend elektrische Betriebsmittel zur Verwendung innerhalb bestimmter Spannungsgrenzen<br/>* Richtlinie 2014/53/UE über Funkanlagen<br/>* Richtlinie 2011/65/UE zur Beschränkung der Verwendung bestimmter gefährlicher Stoffe in Elektro- und Elektronikgeräten<br/>2. Beschreibung der Maschine<br/>a) Produkt: Rasenmäh Roboter<br/>b) Funktion : Gras schneiden<br/>c) Modell d) Typ e) Seriennummer<br/>3. Hersteller und in der Position, die technische Dokumentation zu erstellen<br/>4. Verweis auf aufwendbare Standards<br/>5. 2014/53/UE: ANHANG III (Modul B, EU-Baumusterprüfung)<br/>Die notifizierte Stelle (VDE, 0366) hat EU-Baumusterprüfung und folgende EU-Baumusterprüfbescheinigung ausgestellt:<br/>6. Ort<br/>7. Datum</p> | <p><b>Nederlands (Dutch)</b><br/>EG-verklaring van overeenstemming<br/>1. Ondergetekende, *2, vertegenwoordiger van de constructeur, verklaart hiermee dat het hieronder beschreven machine voldoet aan alle toepasselijke bepalingen van:<br/>* Richtlijn 2006/42/EG betreffende machines<br/>* Richtlijn 2014/30/UE betreffende elektromagnetische overeenstemming<br/>* Richtlijn 2014/35/UE inzake elektrisch materiaal bestemd voor gebruik binnen bepaalde spanningsgrenzen<br/>* Richtlijn 2014/53/UE betreffende radioapparatuur<br/>* Richtlijn 2011/65/UE betreffende beperking van het gebruik van bepaalde gevaarlijke stoffen in elektrische en elektronische apparatuur<br/>2. Beschrijving van de machine<br/>a) Product: Robotmaaiër<br/>b) Functie : gras maaien<br/>c) Model d) Type e) Seriennummer<br/>3. Fabrikant en in staat om de technische documentatie samen te stellen<br/>4. Referentie voor toegepaste normen<br/>5. 2014/53/UE: BIJLAGE III (Module B, EU-typeonderzoek)<br/>De aangemelde instantie (VDE, 0366) heeft een EU-typeonderzoek uitgevoerd en het certificaat van EU-typeonderzoek afgegeven:<br/>6. Plaats<br/>7. Datum</p> |
| Dansk (Danish)   | Ελληνικά (Greek)  | Svenska (Swedish)  | Español (Spanish)   |
| <p><b>Dansk (Danish)</b><br/>EF OVERENSTEMMELSEERKLÆRING<br/>1. UNDERTEGNEDE, *2, SOM REPRÆSENTERER PRODUCENTEN, ERKLÆRER HERMED AT MASKINEN, SOM ER BESKREVET NEDENFOR, OPFYLDER ALLE RELEVANTE BESTEMMELSER I FOLGELSE:<br/>* MASKINDIREKTIV 2006/42/EF<br/>* Direktiv 2014/30/UE om elektromagnetisk kompatibilitet<br/>* Direktiv 2014/35/UE lovgivning om elektrisk materiel bestemt til anvendelse inden for visse spændingsgrænser<br/>* Direktiv 2014/53/UE om radioudstyr<br/>* direktiv 2011/65/UE om begrænsning af anvendelsen af visse farlige stoffer i elektrisk og elektronisk udstyr<br/>2. BESKRIVELSE AF PRODUKTET<br/>a) Produkt: Robotklippekøber<br/>b) ANVENDELSE : Græsklipning<br/>c) Model d) TYPE e) SERIENUMMER<br/>3. PRODUCENT OG I STAND TIL AT UDARBEJDE DEN TEKNISKE DOKUMENTATION<br/>4. HENVISNING TIL anvendte standarder<br/>5. 2014/53/UE: BILAG III (Modul B, EU-typeafprøvning)<br/>det bemyndigede organ (VDE, 0366) har foretaget EU-typeafprøvning og udstedt EU-typeafprøvningsattest:<br/>6. STED<br/>7. DATO</p>   | <p><b>Ελληνικά (Greek)</b><br/>ΕΚ-Αήλωση συμμόρφωσης<br/>1. Ο κάτωθι υπογεγραμμένος, *2, εκπροσωπώντας τον κατασκευαστή, δηλώνει ότι το παρακάτω περιγραφόμενο όχημα πληροί όλες τις σχετικές προδιαγραφές του:<br/>* Οδηγία 2006/42/ΕΚ για μηχανές<br/>* Οδηγία 2014/30/ΕΕ σχετικά με την ηλεκτρομαγνητική συμβατότητα<br/>* Οδηγία 2014/35/ΕΕ αναφερόμενων στο ηλεκτρολογικό υλικό που προορίζεται να χρησιμοποιηθεί εντός ορισμένων ορίων τάσεως<br/>* Οδηγία 2014/53/ΕΕ σχετικά με το ραδιοεξοπλισμό<br/>* Οδηγία 2011/65/ΕΕ για τον περιορισμό της χρήσης ορισμένων επικίνδυνων ουσιών σε ηλεκτρικό και ηλεκτρονικό εξοπλισμό<br/>2. Περιγραφή μηχανήματος<br/>a) προϊόν: Αυτόματο χλοοκοπτικό<br/>b) Λειτουργία : γέ κοψίμα γρασίδιού<br/>c) Μοντέλο d) Τύπος e) Αριθμός σειράς παραγωγής<br/>3. Κατασκευαστής και να είναι σε θέση να καταρτίσει τον τεχνικό φάκελο<br/>4. Παραπομπή στα ισχύοντα πρότυπα<br/>5. 2014/53/ΕΕ: ΠΑΡΑΡΤΗΜΑ ΙΙΙ (Ενότητα Β, Εξέταση τύπου ΕΕ)<br/>ο κωνοποιημένος οργανισμός (VDE, 0366) πραγματοποιήσε Εξέταση τύπου ΕΕ και εξέδωσε το πιστοποιητικό εξέτασης τύπου ΕΕ:<br/>6. Η δοκιμή έγινε<br/>7. Ημερομηνία</p>                          | <p><b>Svenska (Swedish)</b><br/>EG-försäkran om överensstämmelse<br/>1. Undertecknad, *2, representant för tillverkaren, deklarerar härmed att maskinen beskriven nedan fullföljer alla relevanta bestämmelser enligt:<br/>* Direktiv 2006/42/EG gällande maskiner<br/>* Direktiv 2014/30/UE på elektromagnetisk kompatibilitet<br/>* Direktiv 2014/35/UE om elektrisk utrustning avsedd för användning inom vissa spänningssgränser<br/>* Direktiv 2011/65/UE om begränsning av användning av vissa farliga ämnen i elektrisk och elektronisk utrustning<br/>2. Maskinbeskrivning<br/>a) Produkt: Robotgräsklippare<br/>b) Modell d) Typ e) Seriennummer<br/>3. Tillverkare och ska kunna sammanställa teknisk dokumentation.<br/>4. Referens för tillämplad standard<br/>5. 2014/53/UE: BILAGA III (Modul B, EU-typprövning)<br/>det anmälda organet (VDE, 0366) har utfört EU-typprövning och utfärdat EU-typprövningsintyg:<br/>6. Utfärdat vid<br/>7. Datum</p>   | <p><b>Español (Spanish)</b><br/>Declaración de Conformidad CE<br/>1. El firmante, *2, en representación del fabricante, adjunto declara que la máquina abajo descrita, cumple las obligaciones relevantes de:<br/>* Directiva 2006/42/CE de maquinaria<br/>* Directiva 2014/30/UE sobre compatibilidad electromagnética<br/>* Directiva 2014/35/UE sobre el material eléctrico destinado a utilizarse con determinados límites de tensión<br/>* Directiva 2011/65/UE sobre equipos radioeléctricos<br/>* Directiva 2011/65/UE sobre restricciones a la utilización de determinadas sustancias peligrosas en aparatos eléctricos y electrónicos<br/>2. Descripción de la máquina<br/>a) Producto: Robot cortacésped<br/>b) Función : Cortar el césped<br/>c) Modelo d) Tipo e) Número de serie<br/>3. Fabricante que puede compilar el expediente técnico<br/>4. Referencia a normas aplicadas<br/>5. 2014/53/UE: ANEXO III (Módulo B, Examen UE de tipo)<br/>El organismo notificado (VDE, 0366) ha efectuado Examen UE de tipo y expedido el certificado de examen UE de tipo:<br/>6. Realizado en<br/>7. Fecha</p>  |

Table with 4 columns representing different languages: Română (Romanian), Portugués (Portuguese), Polski (Polish), Suomi / Suomen kieli (Finnish), Magyar (Hungarian), Čeština (Czech), Latviešu (Latvian), Slovenčina (Slovak), Eesti (Estonian), Slovensčina (Slovenian), Lietuvių kalba (Lithuanian), Български (Bulgarian), Norsk (Norwegian), Türk (Turkish), Íslenska (Icelandic), Hrvatski (Croatian).

# LCD MENU INDEX

| Menu name                  | Step  | Page |
|----------------------------|---|------|
| <b>A</b> Alarm             | System settings → Security                    | P.51 |
| Auto mode                  | Garden setup → Auto mode                      | P.31 |
| <b>B</b> BG color          | System settings → Display/Sound               | P.49 |
| <b>C</b> Check signal      | Diagnostics                                   | P.43 |
| Contrast                   | System settings → Display/Sound               | P.49 |
| Create a PIN               | System settings → Security                    | P.51 |
| <b>D</b> Date and time     | System settings                               | P.50 |
| Docking direction          | Garden setup → Garden layout                  | P.40 |
| <b>E</b> Edge cutting      | Garden setup → Auto mode → Advanced setting   | P.35 |
| <b>F</b> Factory reset     | System settings                               | P.52 |
| Fault history              | History                                       | P.48 |
| <b>G</b> Garden layout     | Garden setup                                  | P.40 |
| <b>H</b> Help              | System settings                               | P.52 |
| History                    | History                                       | P.46 |
| Home                       | Garden setup → Homing setup                   | P.42 |
| Homing setup               | Garden setup → Homing setup                   | P.41 |
| <b>K</b> Keypad            | System settings → Display/Sound               | P.50 |
| <b>L</b> Language          | System settings                               | P.49 |
| <b>M</b> Manual mode       | Garden setup → Manual mode                    | P.38 |
| Mowing pattern             | Garden setup → Manual mode                    | P.38 |
| Mowing start points        | Garden setup → Auto mode → Mowing start point | P.33 |
| Mowing start Points        | Work timer                                    | P.28 |
| <b>N</b> Narrow passage    | Garden setup → Auto mode → Advanced setting   | P.37 |
| <b>O</b> Operating time    | History → Operating history                   | P.46 |
| Operation history          | History                                       | P.46 |
| <b>P</b> Passage width     | Garden setup → Homing setup                   | P.41 |
| <b>Q</b> Quiet timer       | Work timer                                    | P.30 |
| <b>S</b> Seasonal timer    | Work timer                                    | P.29 |
| Security                   | System settings                               | P.51 |
| Setup wizard               | Setup wizard                                  | P.15 |
| Sound                      | System settings                               | P.49 |
| Spiral cutting             | Garden setup → Auto mode → Advanced setting   | P.36 |
| Spiral cutting             | Garden setup → Manual mode                    | P.38 |
| <b>T</b> Test start points | Diagnostics → Test start points               | P.44 |
| <b>W</b> Wire length       | Garden setup → Garden layout → Wire length... | P.40 |
| Wire overlap               | Garden setup → Auto mode → Advanced setting   | P.34 |
| Work history               | History → Operating history                   | P.47 |
| Work timer                 | Work timer                                    | P.27 |

# LAWN DIAGRAM

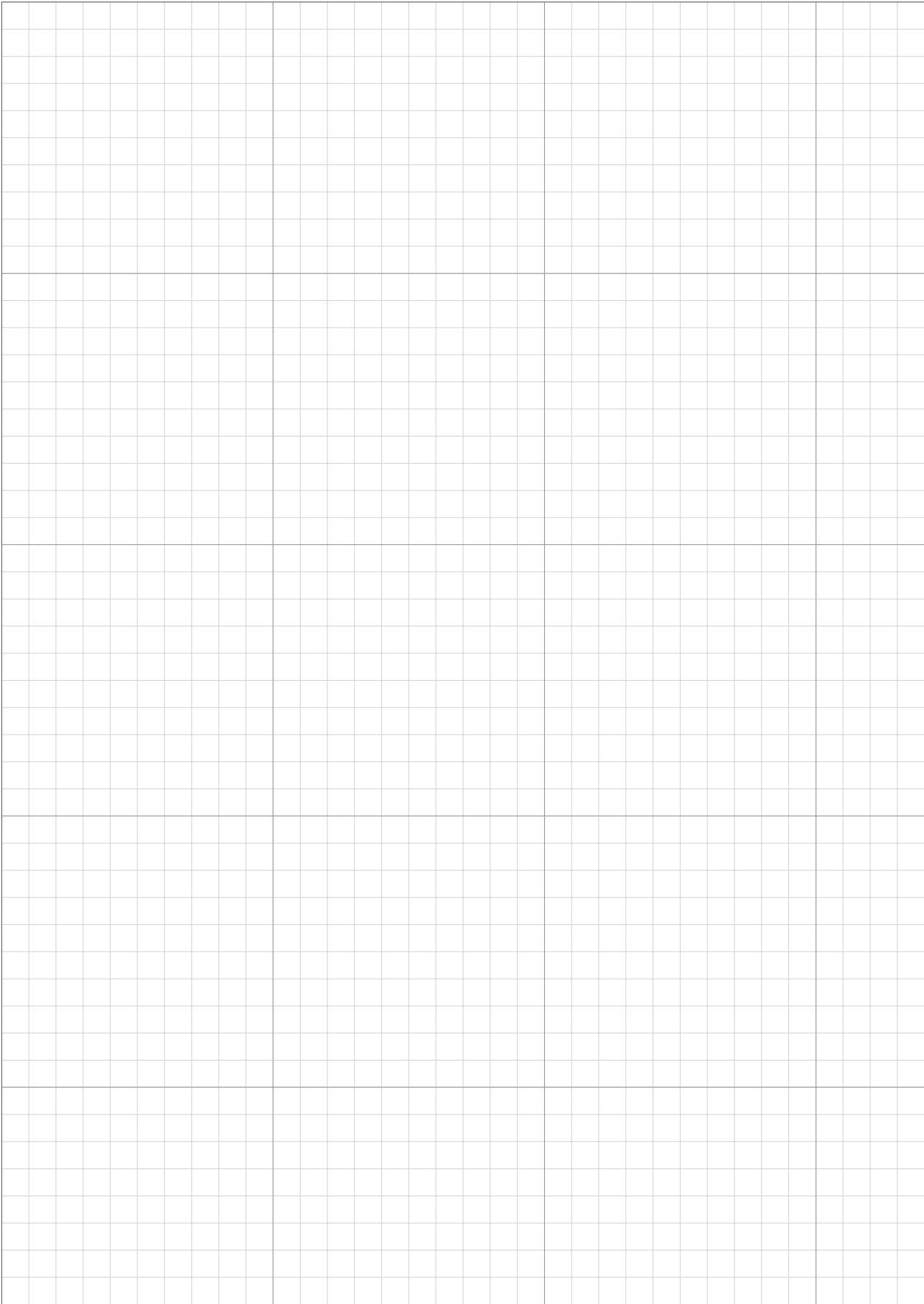

# DEALER CHECKSHEET

The following information is provided by your dealer after setup is complete.

## Basic setting information (pages 16, 51)

PIN (Personal Identification Number):

|  |  |  |  |
|--|--|--|--|
|  |  |  |  |
|--|--|--|--|

Language : English / Deutsch / Français / Italiano / Nederlands / Svenska / Norsk / Español / Polski / Dansk / Suomalainen / Čeština / Português

## Setup wizard setting information (page 17)

The following items are related to the basic settings for Setup wizard.

### Garden layout (page 17)

Direction: Clockwise / Anticlockwise      Wire length: \_\_\_\_\_ m

Garden size: \_\_\_\_\_ m<sup>2</sup>      Narrow passage: \_\_\_\_\_ cm

### Mowing start point (page 19)

| Starting points | Direction | From station to start point | Area percentage |
|-----------------|-----------|-----------------------------|-----------------|
| Point 1         | CW / ACW  | m                           | %               |
| Point 2         | CW / ACW  | m                           | %               |
| Point 3         | CW / ACW  | m                           | %               |
| Point 4         | CW / ACW  | m                           | %               |
| Point 5         | CW / ACW  | m                           | %               |

### Work timer (page 22)

| Day of the week | Timer 1           | Timer 2           | Starting point    |
|-----------------|-------------------|-------------------|-------------------|
| Monday          | __ : __ - __ : __ | __ : __ - __ : __ | 1 / 2 / 3 / 4 / 5 |
| Tuesday         | __ : __ - __ : __ | __ : __ - __ : __ | 1 / 2 / 3 / 4 / 5 |
| Wednesday       | __ : __ - __ : __ | __ : __ - __ : __ | 1 / 2 / 3 / 4 / 5 |
| Thursday        | __ : __ - __ : __ | __ : __ - __ : __ | 1 / 2 / 3 / 4 / 5 |
| Friday          | __ : __ - __ : __ | __ : __ - __ : __ | 1 / 2 / 3 / 4 / 5 |
| Saturday        | __ : __ - __ : __ | __ : __ - __ : __ | 1 / 2 / 3 / 4 / 5 |
| Sunday          | __ : __ - __ : __ | __ : __ - __ : __ | 1 / 2 / 3 / 4 / 5 |

### Seasonal timer:

Region: North / North Central / South Central / South

Percentage: JAN : \_\_\_\_\_ %    FEB : \_\_\_\_\_ %    MAR : \_\_\_\_\_ %    APR : \_\_\_\_\_ %

MAY : \_\_\_\_\_ %    JUN : \_\_\_\_\_ %    JUL : \_\_\_\_\_ %    AUG : \_\_\_\_\_ %

SEP : \_\_\_\_\_ %    OCT : \_\_\_\_\_ %    NOV : \_\_\_\_\_ %    DEC : \_\_\_\_\_ %



## Other setting item information

Please fill the following items if configuring them with the Menu settings.

### Garden layout setting information (pages 33, 37, 40, 41)

#### Passage width:

 **Home screen** → [2.Garden setup] → [1.Auto mode] → [1.Mowing start points] → [1.Point 1] to [5.Point 5]

Point 1: \_\_\_\_ - \_\_\_\_    Point 2: \_\_\_\_ - \_\_\_\_    Point 3: \_\_\_\_ - \_\_\_\_  
Point 4: \_\_\_\_ - \_\_\_\_    Point 5: \_\_\_\_ - \_\_\_\_

#### Narrow passage:

 **Home screen** → [2.Garden setup] → [1.Auto mode] → [3.Advanced setting] → [4.Narrow passage]

1: Direction: CW / ACW    From: \_\_\_\_ m    To: \_\_\_\_ m  
2: Direction: CW / ACW    From: \_\_\_\_ m    To: \_\_\_\_ m  
3: Direction: CW / ACW    From: \_\_\_\_ m    To: \_\_\_\_ m  
4: Direction: CW / ACW    From: \_\_\_\_ m    To: \_\_\_\_ m

#### Shortcut wire:

 **Home screen** → [2.Garden setup] → [3.Garden layout] → [2.Wire length...]  
Yes / No

#### Passage width (Homing):

 **Home screen** → [2.Garden setup] → [4.Homing setup] → [1.Passage width]  
Value: \_\_\_\_

### Useful features information (pages 30, 35, 36)

 **Home screen** → [1.Work timer] → [4.Quiet timer]  
Quiet timer: ON / OFF

 **Home screen** → [2.Garden setup] → [1.Auto mode] → [3.Advanced setting]  
Edge cutting: ON / OFF  
Spiral cutting: ON / OFF

### System setup (Docking station) (page 40)

 **Home screen** → [2.Garden setup] → [3.Garden layout] → [1.Docking direction]  
Loop Direction: CW / ACW

Your dealer's contact information is below:

Dealer:

Tel:

Mail:

# QUICK GUIDE

## Fundamentals

Turning on / off the power  
(☞ page 11, 54)

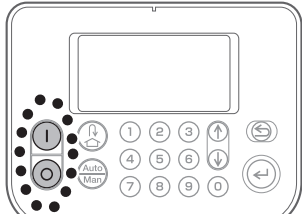

Sending back home  
(☞ page 11)

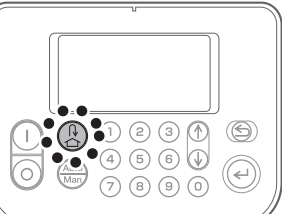

Stopping the lawnmower  
(☞ page 10)

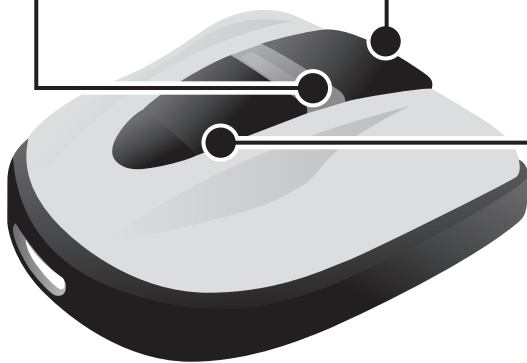

Adjusting the cutting height  
(☞ page 57)

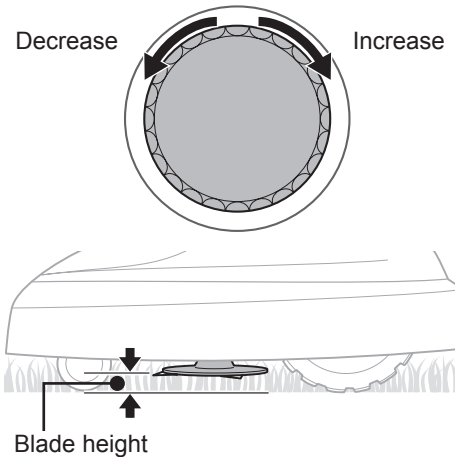

| Position | Approximate blade height |
|----------|--------------------------|
| 1        | 20 mm                    |
| 2        | 30 mm                    |
| 3        | 40 mm                    |
| 4        | 50 mm                    |
| 5        | 60 mm                    |

## Daily use

### 1 Menu settings



Configure the operation mode, timer, and other settings.

- Work settings for the garden
  - Mowing start point settings (☞ page 28)
  - Narrow passage settings (☞ page 33)
  - Mowing pattern settings (☞ page 38)
- Timer settings (☞ page 27)
- Useful settings (☞ page 29, 30, 38)
- Operation checks (☞ page 43)
- Setup wizard (☞ page 15)

### 2 Check the garden

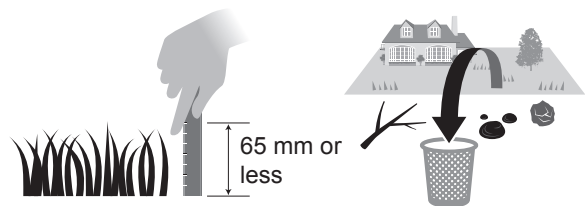

Maintain the area before the lawnmower starts mowing.

- Checking the garden (☞ page 53)
- Removing foreign objects from the area (☞ page 53)



## Technical tips

### Mowing mode

You can select from 2 modes of operation (available in “Menu Settings”).

- **Auto mode** (☞ page 31)

The lawnmower automatically mows according to inputted time and garden settings.

- **Manual mode** (☞ page 38)

Start mowing anytime without timer settings.

### Cleaning the lawnmower (☞ page 64)

Clean dirt and grass off of the lawnmower using a brush and cloth.

Remove dirt and grass from the following areas:

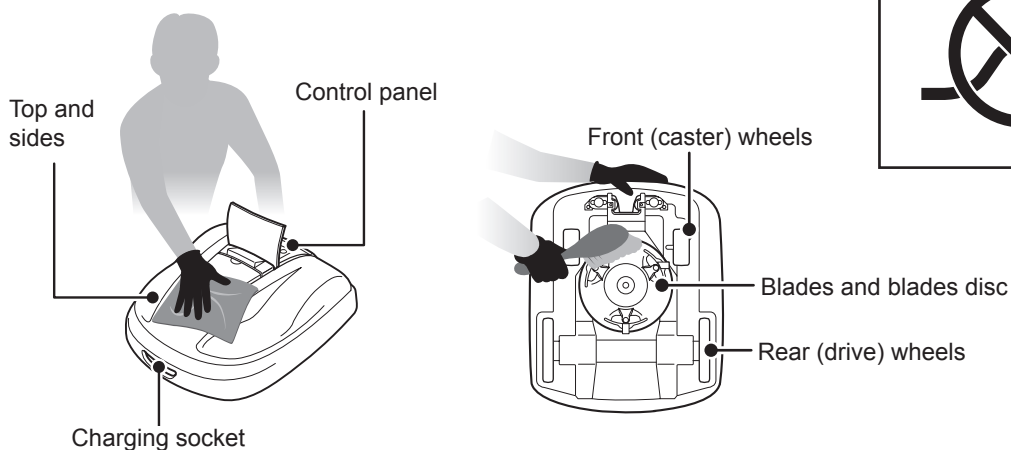

#### NOTE:

- Do not clean the lawnmower with solvent, a high-pressure cleaner, a garden hose, etc.



## 3 Paused

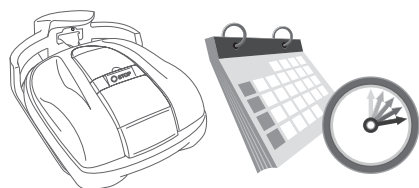

Put on “Paused” state for work so you can start operation at your desired time.

- Adjusting the height of the blades (☞ page 57)
- Checking the “Paused” state (☞ page 54)
- Checking the docking station connections (☞ page 53)

## 4 Weekly check



Regularly check the lawnmower for assurance.

- Checking the standby status (☞ page 54)
- Checking the docking station connections (☞ page 66)
- Blade conditions (☞ page 68)
- Checking the parts (☞ page 63, 65)

## 5 Storage



Store properly for next use.

- Cleaning and replacing the blades (☞ page 70)
- Cleaning the lawnmower (☞ page 64)
- Cleaning the docking station (☞ page 66)
- Disconnecting the transformer and power cable (☞ page 53)





# HONDA

The Power of Dreams



32VP7633  
00X32-VP7-6330

© Honda Motor Co., Ltd. 2018

HRM310K1  
HRM520K1  
xxxx.xxxx.xx  
xxxx.xxxx.xx